

THE SCIENCE

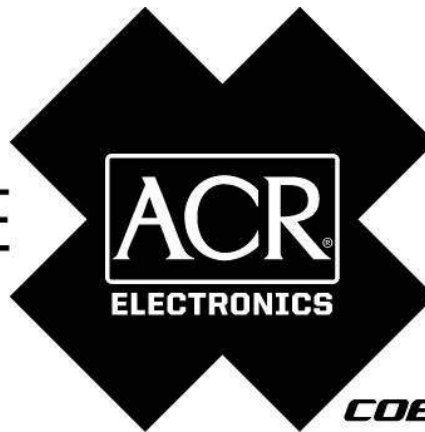

OF SURVIVAL

COBHAM

USER MANUAL

NAUTICAST™ Inland AIS // Automatic Identification System

Product No.: 2662

Y1-03-0211 Rev. G

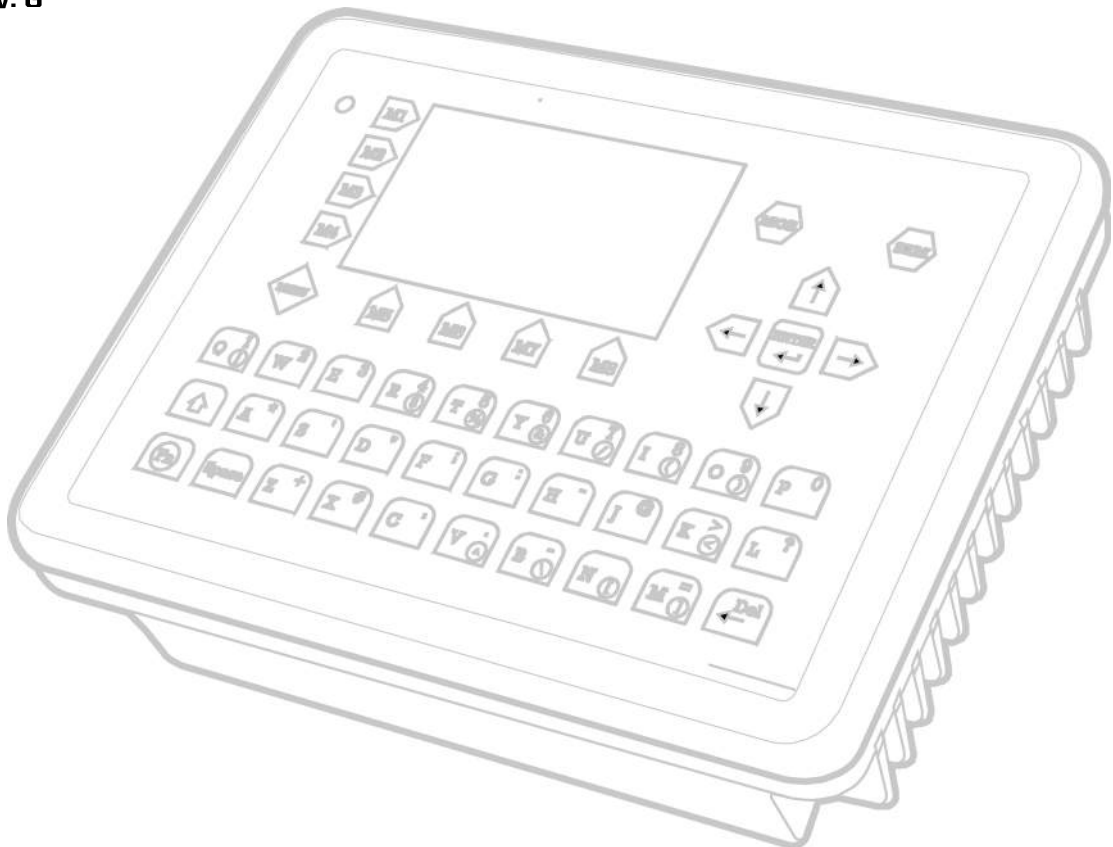

FC

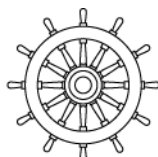

ACR Electronics, Inc. // 5757 Ravenswood Road // Fort Lauderdale // FL // 33312-6645

Tel: +1 (954) 981-3333 // Fax: +1 (954) 983-5087 // www.acrelectronics.com

Please read this first!

Warning:

Although ACR strives for accuracy in all its publications; this material may contain errors or omissions, and is subject to change without prior notice. ACR shall not be made liable for any specific, indirect, incidental or consequential damages as a result of its use. ACR components may only be used in safety of life devices or systems, with the express written approval of ACR, as the failure of such components could cause the failure of the ACR device or system. If these fail, it is reasonable to assume that the safety of the user or other persons may be endangered.

Copying of this document, and giving it to others and the use or communication of the contents thereof, are forbidden without express authority. Offenders are liable to the payment of damages.

1	STARTING THE NAUTICAST™	5
1.1	Initial Set Up of the NAUTICAST™ for operation	5
1.2	Entering the MMSI / IMO / DAC / ESN Numbers	6
1.3	Entering Ship Settings	8
1.4	Entering Voyage Related Data	9
1.5	Service and User Passwords	13
2	NAUTICAST™ INLAND AIS USER INTERFACE	16
2.1	NAUTICAST™ Keyboard	16
2.2	Explanation of the “Cursor Cross”	16
2.3	Explanation of the Num-Locked and [NUM] Functions	17
2.4	Explanation of the Soft Keys	17
2.5	Safety Keys	17
3	NAUTICAST™ SCREENS	18
3.1	Navigation Screen	18
3.1.1	Own Vessel Data	19
3.1.2	Other Vessel Data	20
3.1.3	Short Header	20
3.1.4	Other Vessel Details	21
3.2	Menu Structure	23
3.3	Main Menu	23
3.4.1	Messages	24
3.4.2	AIS Status	24
3.4.3	Voyage Settings – (User Password Protected)	24
3.4.4	Ship Settings – (User Password Protected)	25
3.4.5	Transponder Configuration – (User Password Protected)	25
3.4.6	Service Configuration – (Service Password Protected)	25
3.4.7	Display Settings	26
3.4.8	Graphical Display Settings	26
3.5	Sub-Menus Detailed	27
3.5.1	Messages	27
3.5.2	AIS Status	39
3.5.3	Voyage Settings (User Password Protected)	42
3.5.4	Ship Settings (User Password Protected)	47
3.5.5	Transponder Configuration (User Password Protected)	50
3.5.6	Service Configuration (Service Password Protected)	60
3.5.7	Display Settings	68
3.6	Graphical User Interface (GUI)	68
3.6.1	Switching between the Views	70
3.6.2	The Radar View	71
3.6.3	The Fairway View	75
3.6.4	Message and Alarm Handling	79
3.6.5	Configuration of the Graphical Display	80
4	SAFETY FUNCTIONS	85
4.1	MOB Person over Board	86
4.2	Activating the SRM Safety Related Message Button	87
5	TROUBLESHOOTING	90
5.1	Reading and understanding Alarms:	90
5.2	Alarm Codes	91
5.3	Text Messages	92
5.4	Restarting the NAUTICAST™	92
6	CONTACT AND SUPPORT INFORMATION	92
7	APPENDIX	93
7.1	Explanation of commonly used Abbreviations	93
7.2	ERI ship types	94
7.3	Password Settings	97

History of Changes

Date	Version	Rev.	Status	Comments	Responsible
2005-11-01	1.0.0	A	Released	Initial Release	A. Lesch
2006-07-25	1.0.1	B	Released	Editorial work	M.D'Arcangelo
2006-11-06	1.0.2	C	Released	Screen Display Updates	M.D'Arcangelo
2008-12-05	1.0.5	D	Released	Update according to VTT&T, Adaptation for new function in Software 2.0.S116.W225, Factory Password handling, removed reference to specific default password and noted this is now on the protective cover on the unit display.	C. Kabinger, B. Werner
2009-09-15	1.0.7	E	Released	Screen display updates due to the changes during the certification process ITU-R M.1371-3	A. Lesch
2009-10-27	1.0.8	F	Released	Software dependencies	B. Werner
2010-05-12	1.0.9	G	Released	New function water levels	B. Werner

Software dependencies

This revision of the Manual is valid for the Software version (s) below stated and future versions unless otherwise noted (ref.: www.acrelectronics.com / www.acr-europe.com .

Date	AIS software Version	Status	Comments	Responsible
2010-05-25	2.0.S116.A526	Released	New water level message	A. Lesch

1 Starting the NAUTICAST™

1.1 Initial Set Up of the NAUTICAST™ for operation

NOTE: AUTHORITIES MANDATE THAT YOU ENTER THIS INFORMATION.

After installing the antennas and hardware the following User, Voyage related and Ship Settings data needs to be entered. Upon Start-up (Applying power) enter the following information.

- a) Enter MMSI Number - See paragraph 1.2 on entering information. During the initial boot or after “factory settings” the user is asked to enter a valid MMSI number. As long as this is not done, the system does not transmit. This appears as Alarm-ID 56 with the text “AIS: ENTER MMSI NUMBER”.

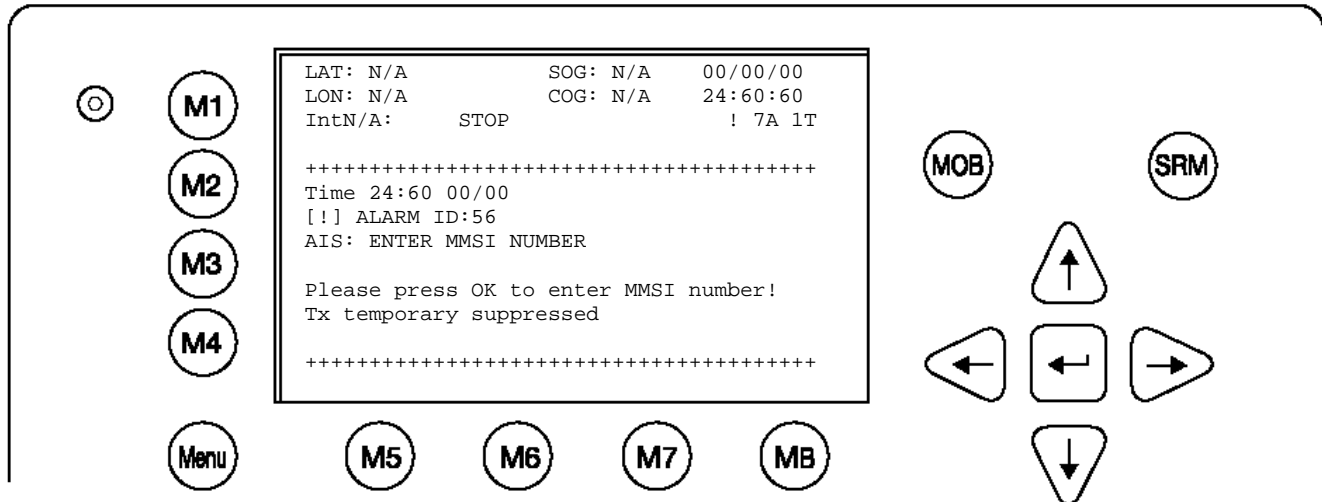

- b) Enter IMO Number, Designated Area Code (DAC) and European Ship Number (ESN) - See paragraph 1.2 on entering information.
- c) Select AIS Mode – According to the local requirements you have to select the AIS Mode between Inland AIS or SOLAS AIS. See paragraph on altering this information.
- d) Ship Settings Data - After initial entry of the Ship Settings Data any changes in the information below should be edited accordingly. See Paragraph 0 on entering information.
- Enter Call Sign
 - Enter Ships Name
 - Enter Length of Ship
 - Enter Beam of Ship
 - Enter Internal GPS antenna Position
 - Enter External GPS Antenna Position (If Applicable).
 - Enter Ship Type
- e) Voyage related Data – After initial entry of the Voyage related Data any changes in the information below should be edited accordingly. See paragraph 1.4 on entering information.
- Enter Cargo Type
 - Enter Draught
 - Enter Destination
 - Enter ETA
 - Enter Navigation Status.
- f) Password – Service and User passwords see section 1.5 and Appendix 7.3

1.2 Entering the MMSI / IMO / DAC / ESN Numbers

Select from the Main Menu “**Service Configuration**” **Number 6**. The default password from the factory is mentioned on your AIS display at the protection foil. (see Appendix 7.3 for password information). Enter Service Password and use the up and down arrows on keypad to select “Change MMSI / IMO” than press M5 “Select” or “by pressing number 3 on the keypad.

Input your MMSI and IMO number and press Save to store data. Unit will reboot itself after pressing Save. Continue to 4.2 after reboot, if no IMO number is available use the value 0 (Zero).

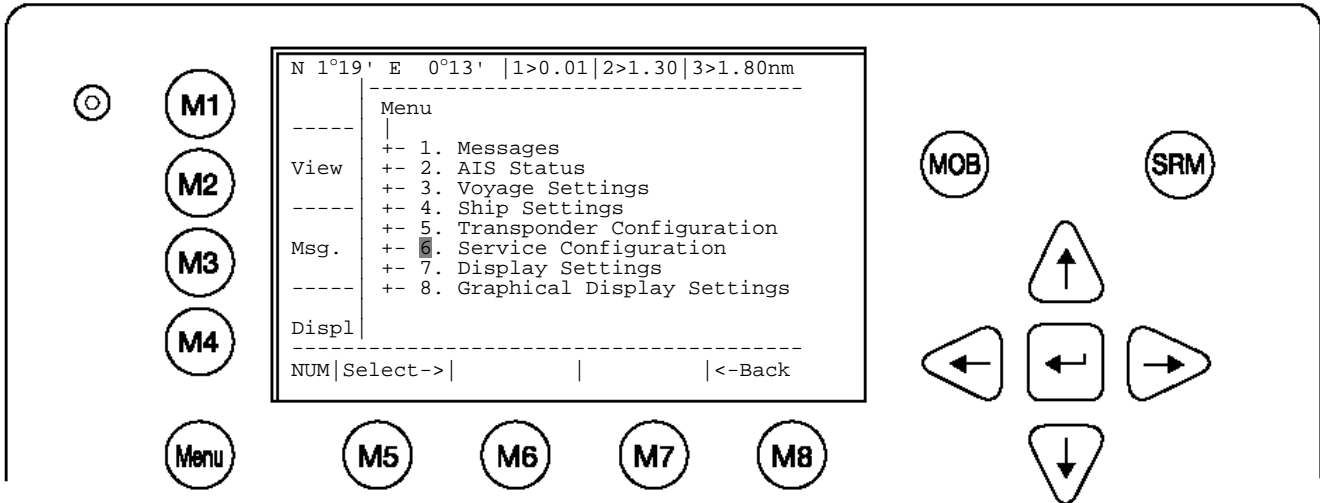

Service Configuration Menu Example:

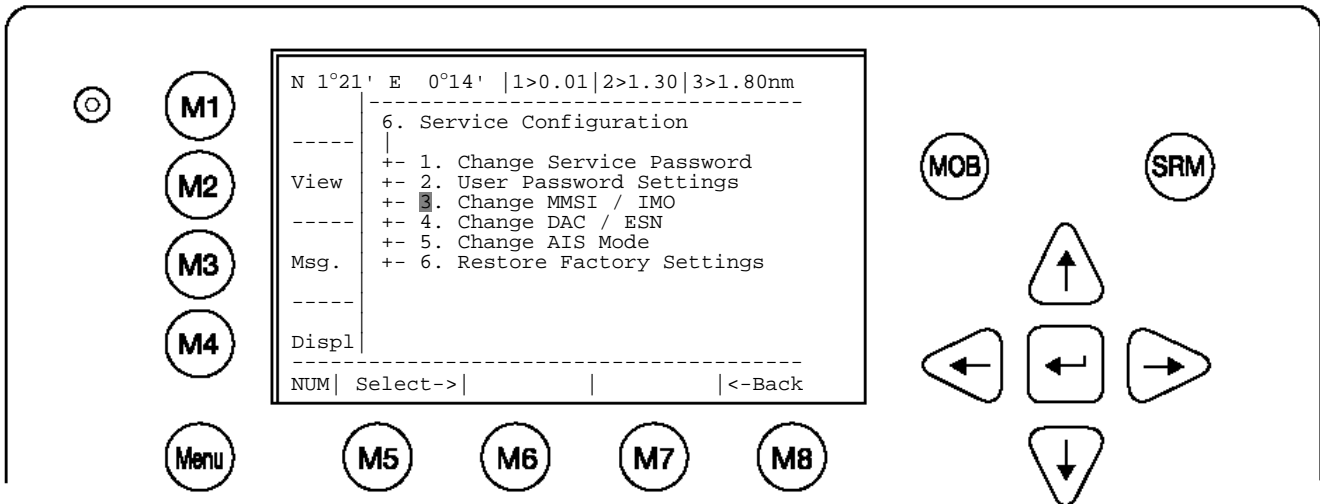

NOTE: MMSI and IMO Data input are limited to 9 characters.

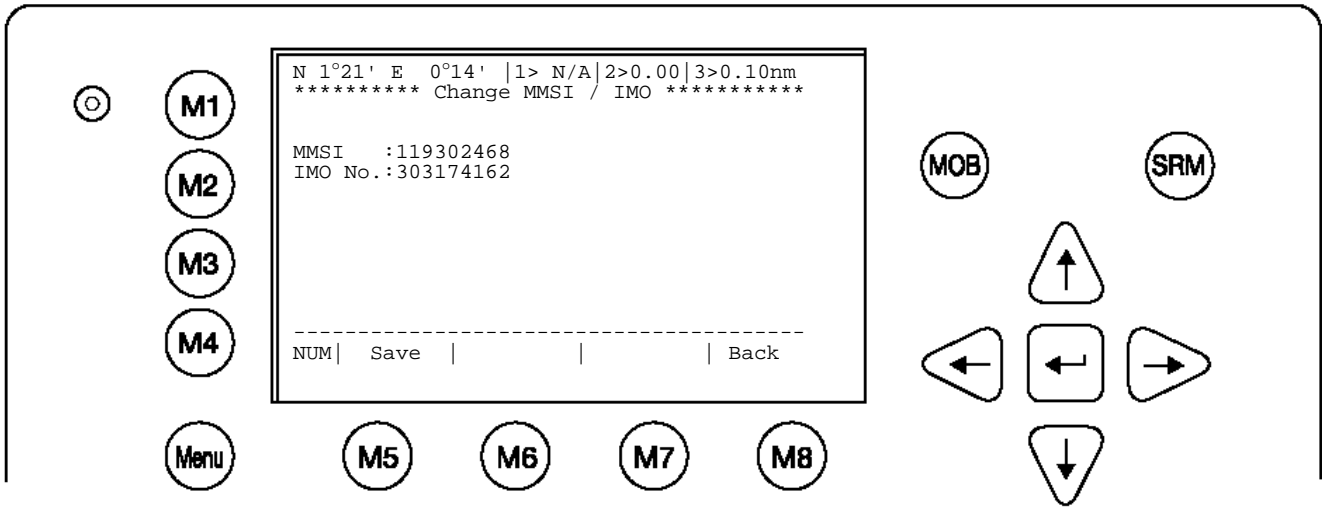

Select Submenu 4 “Change DAC / ESN” with cursor button [Up] & [Down] by pressing No. 4 on the keyboard.

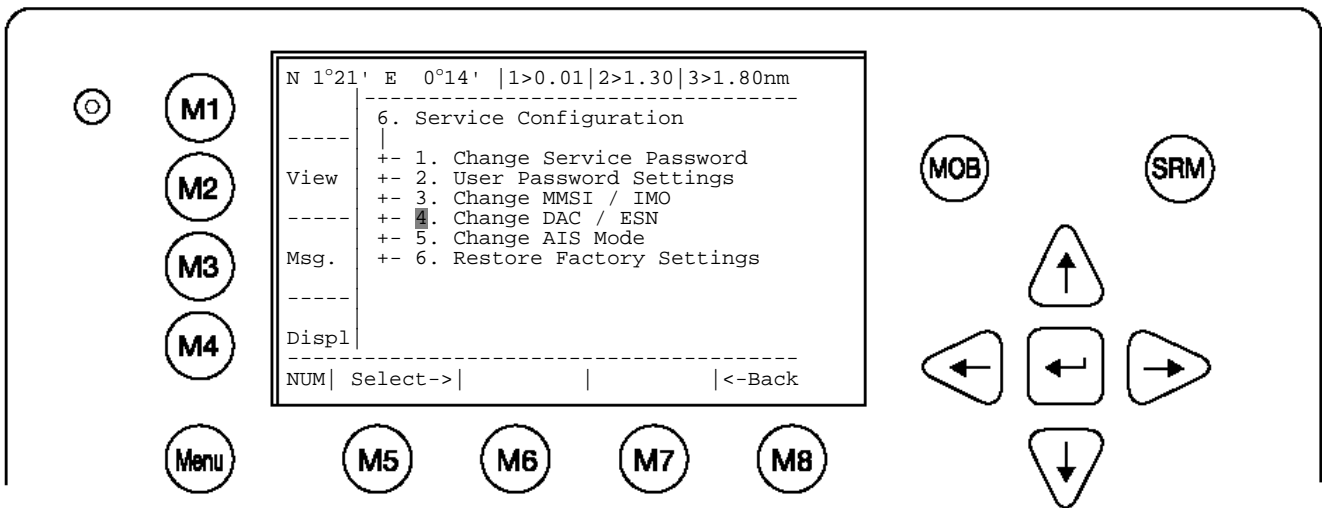

Input new DAC / ESN Numbers and press [Save] to store input data. Press [Back] to return to the Submenu without saving.

NOTE: The DAC (Designated Area Code) is predefined with the value “200”. Please key in only a different 3 digit value if your authority wants you to do this. Otherwise you may lose important AIS information. The ESN (European Ship Number) is limited to 8 ASCII characters.

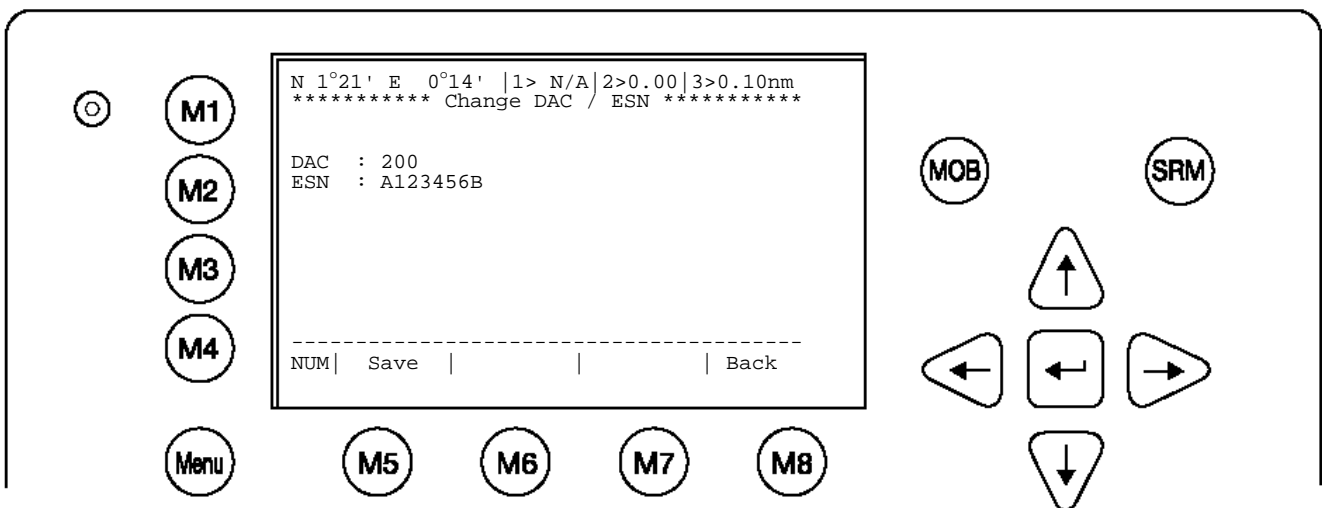

1.3 Entering Ship Settings

Select from the Main Menu “Ship Settings” Menu is USER password protected. The default password from the factory is mentioned on your AIS display at the protection foil. (see Appendix 7.3 for password information). Enter Password and use the up and down arrows to edit Ship Settings then press Enter or the numeric reference on the keypad to select and edit.

Save after editing.

Main Menu Example:

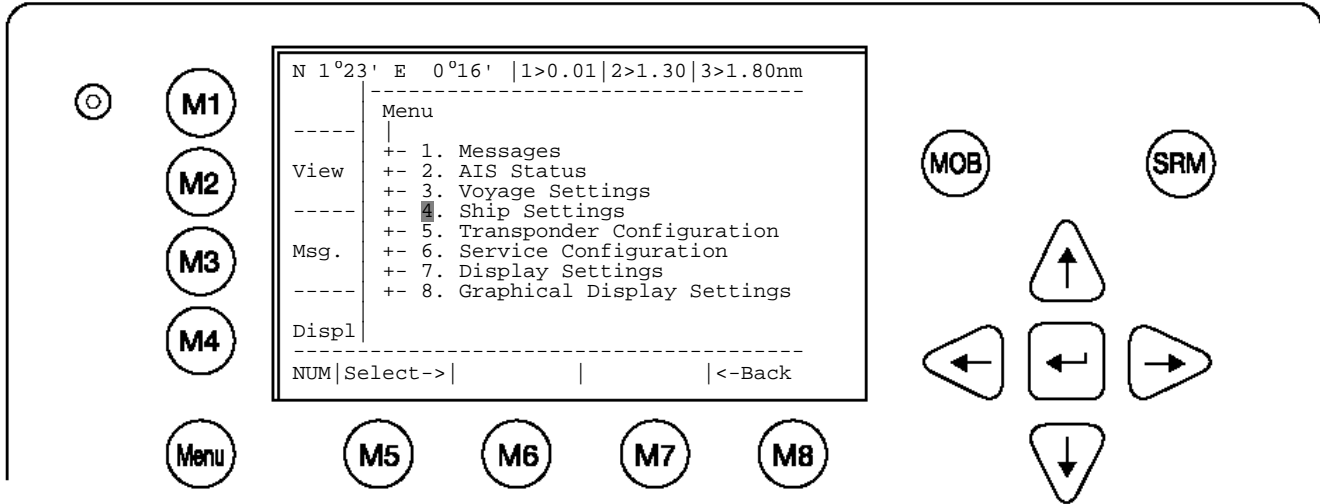

Select Ship Settings and press M5 [Enter]. Enter User Password and Continue.

Ship Settings Menu Example:

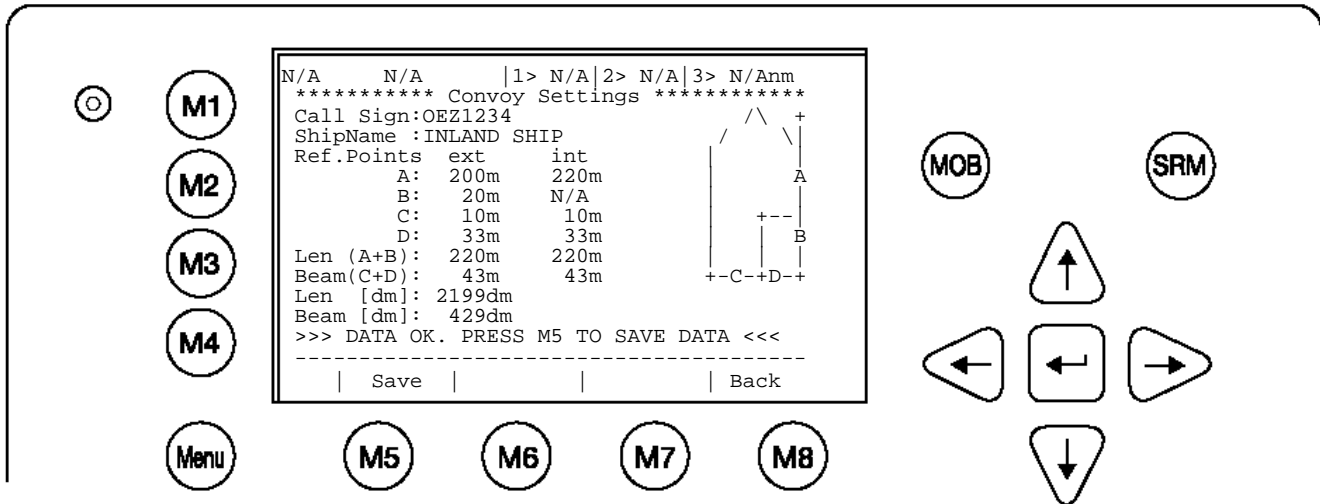

- Select and enter Call Sign (ATIS).
- Select and enter Ship Name.
- Enter external GPS Antenna Position
- Enter internal GPS Antenna Position
- Enter ship len and beam in [dm]

Setting the Internal and External GPS Antenna Position.

Note: It is critical for the proper orientation of your ship to other AIS users to enter this data accurately.

Example: Length of ship = 220m and Beam = 43m.

GPS ANTENNA location on ship (is x in above Menu example) is located 200 meters from bow (A) and 33 Meters from Starboard side (D).

Note: If no external GPS is connected, then enter same data as for internal GPS. External GPS antenna reference point must be filled in before you can save.

Ref.Points ext (Position of the external GPS antenna)

- A = 200m the distance from bow (front) to the antenna.
- B= 20m the distance from the antenna to the stern (rear)
- C = 10m the distance from the port (left) side to the antenna
- D = 33m the distance from the antenna to the starboard (right) side

Enter Ref.Point int (location of the internal GPS antenna) in the same way.

- A = 220m the distance from bow (front) to the antenna.
- B= 0m the distance from the antenna to the stern (rear)
- C = 10m the distance from the port (left) side to the antenna
- D = 33m the distance from the antenna to the starboard (right) side

Your int/ext reference points must match the entered ship dimensions. Length of ship = 220m and Beam = 43m. For incorrect dimension the AIS shows:

```
>>> ext/int ship len/beam don't match
```

Rounded up value of Len and Beam in [dm] must match Len (A+B) and Beam (C+D) in [m] other the AIS shows:

```
>>> Convoy len must match rounded A+B
```

After correct settings of the reference points and dimensions you can press **M5 - [Save]**. to save your settings:

```
>>> DATA OK. PRESS M5 TO SAVE DATA <<<
```

1.4 Entering Voyage Related Data

Select from the Main Menu “Voyage Settings” Menu is USER password protected. The default password from the factory is mentioned on your AIS display at the protection foil. (see Appendix 7.3 for password information). Enter Password and use the up and down arrows to edit Voyage Related data then press Enter or the numeric reference on the keypad to select and edit.

Save after editing.

Main Menu Example:

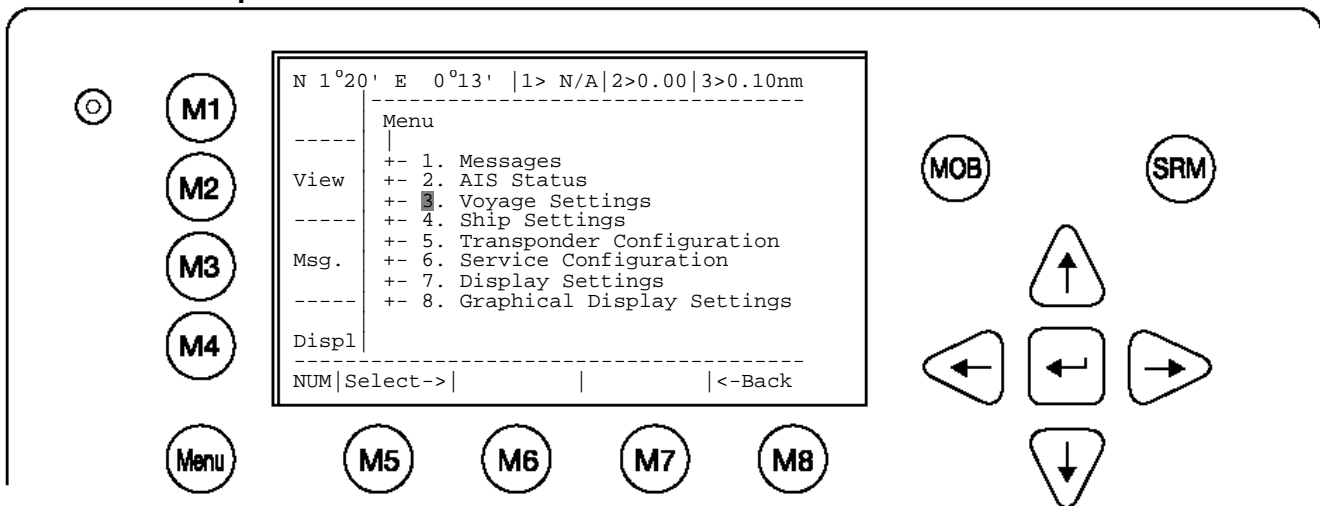

Sub Menu

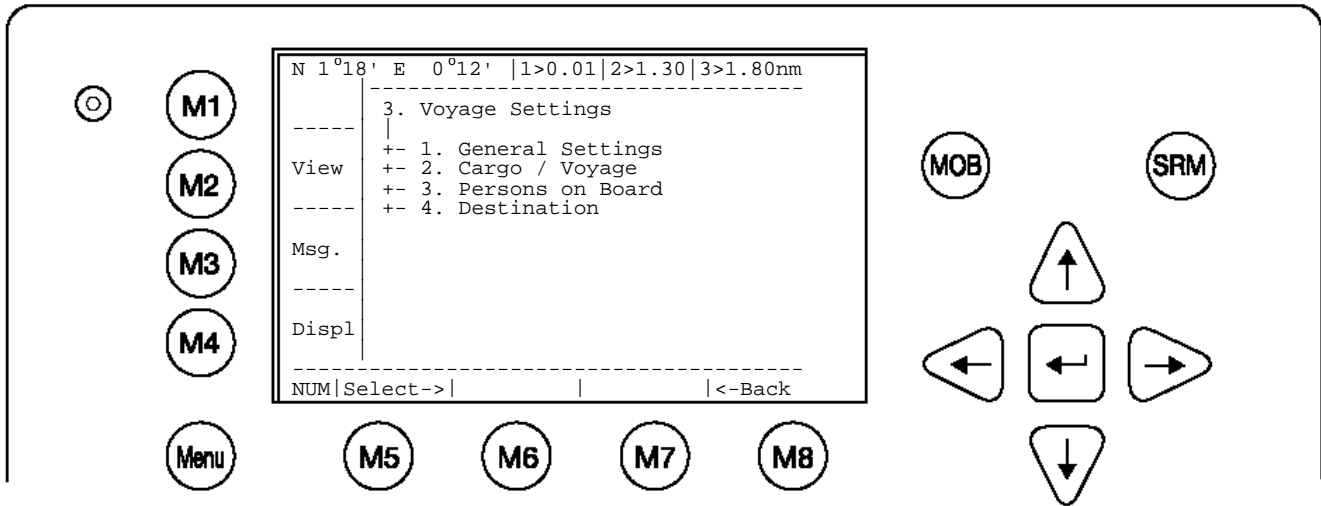

Select Submenu 1 “General Settings” with cursor button [Up] & [Down] by pressing No. 1 on the keyboard.

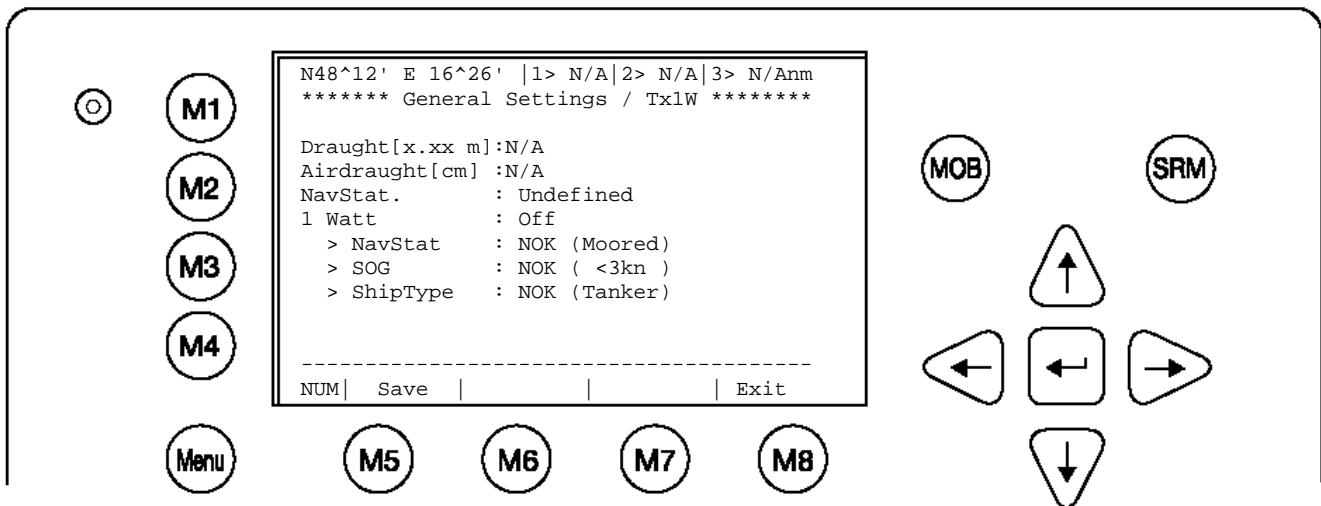

Draught: Scroll the Data Fields with [Enter] and input own vessel data. Enter a SOLAS draught in meter (max. = 20.00m).

Airdraught: Enter air-draught value in centimeter (max. = 4000cm).

NavStat: Enter Navigation state, toggle with [left] and [right] cursor key.

Save the new settings by pressing [Save], and return to the Main Menu Screen by pressing [Exit]. Press [Exit] to return to the Main Menu without saving any changes.

Select Submenu 2 “Cargo/Voyage Settings” with cursor button [Up] & [Down] or by pressing No. 2 on the keyboard.

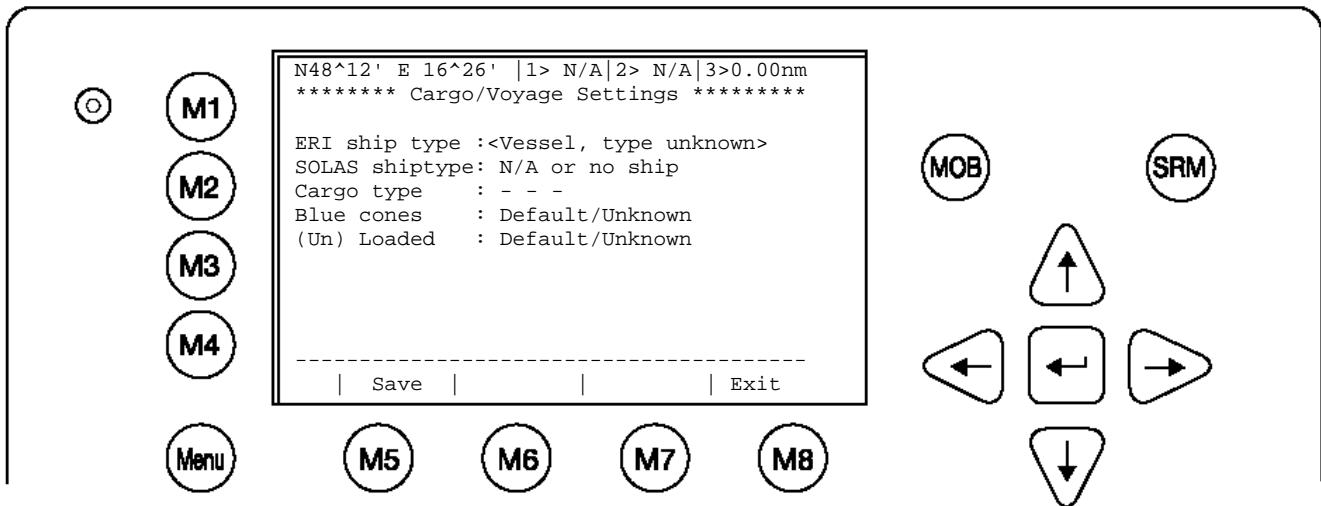

Toggle the values for the **ERI ship type** (see Appendix 7.2), the hazardous cargo by the number of **Blue Cones** [0-3, B-Flag, Default/Unknown], and the loaded / unloaded status **Un/ Loaded** [Loaded, Unloaded].

Save the new settings by pressing [Save], and return to the Main Menu Screen by pressing [Exit]. The ERI ship types, which are used in Inland message 10, are automatically converted to the IMO types which are used in IMO message 5 (refer to Appendix 7.2.). Press [Back] to return to the Main Menu without saving any changes.

Select Submenu 3 “Persons on Board” with cursor button [Up] & [Down] or by pressing No. 2 on the keyboard.

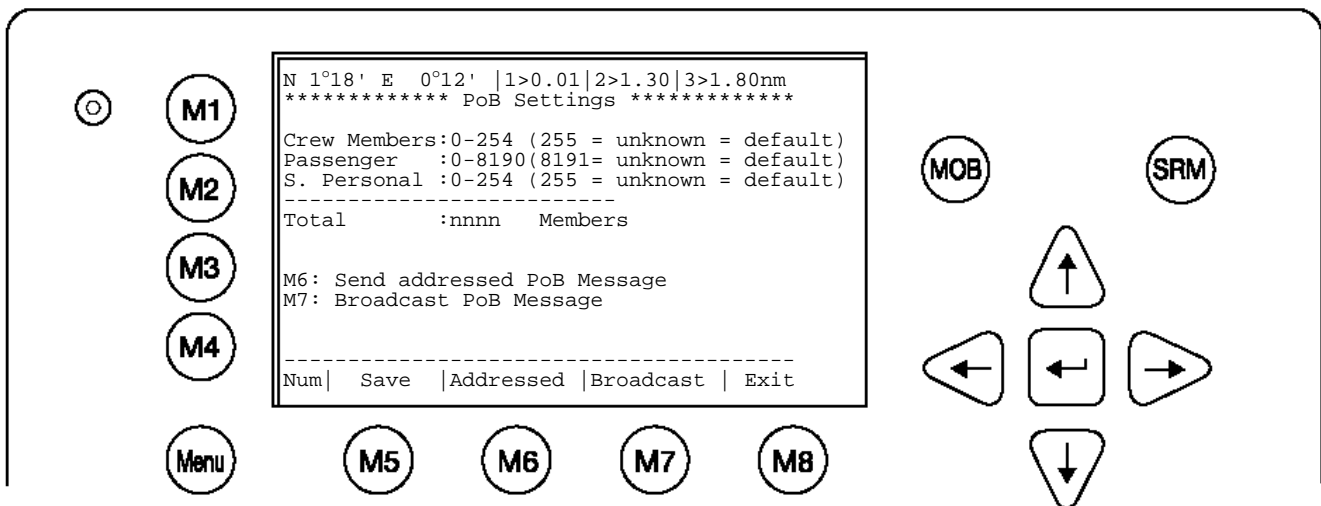

NOTE: The total number of persons on board will be calculated automatically. In “High Seas” mode this sum will be used for the AIS messages. How to use this menu to transfer PoB – information will be described in detail in the User Manual.

Select Submenu 4 “Destination” with cursor button [Up] & [Down] by pressing No. 4 on the keyboard.

Select between mask input and direct input of the destination string.

Mask input:

Scroll the Data Fields with [Enter] and input the UN destination codes as well as the ETA (estimated time of arrival) data.

Save the new settings by pressing [Save], and return to the Main Menu Screen by pressing [Exit]. Press [Exit] to return to the Main Menu without saving any changes.

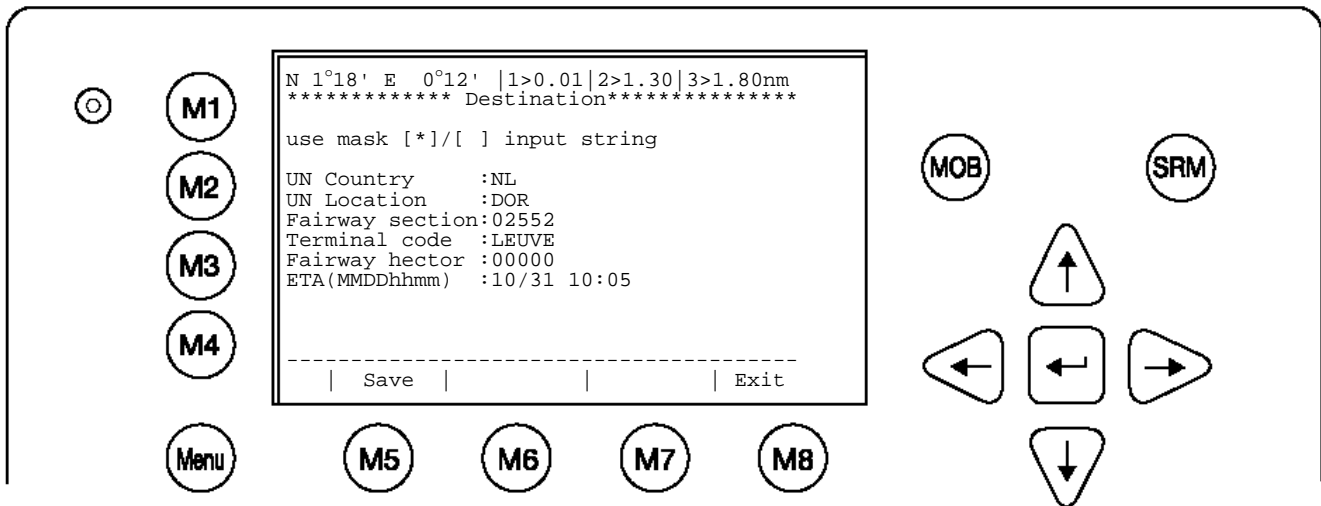

String Input:

Direct input of all entries above as string.

NOTE: All characters are allowed. Its in the users responsibility to enter the correct length for all entries. The above mask would be entered as:

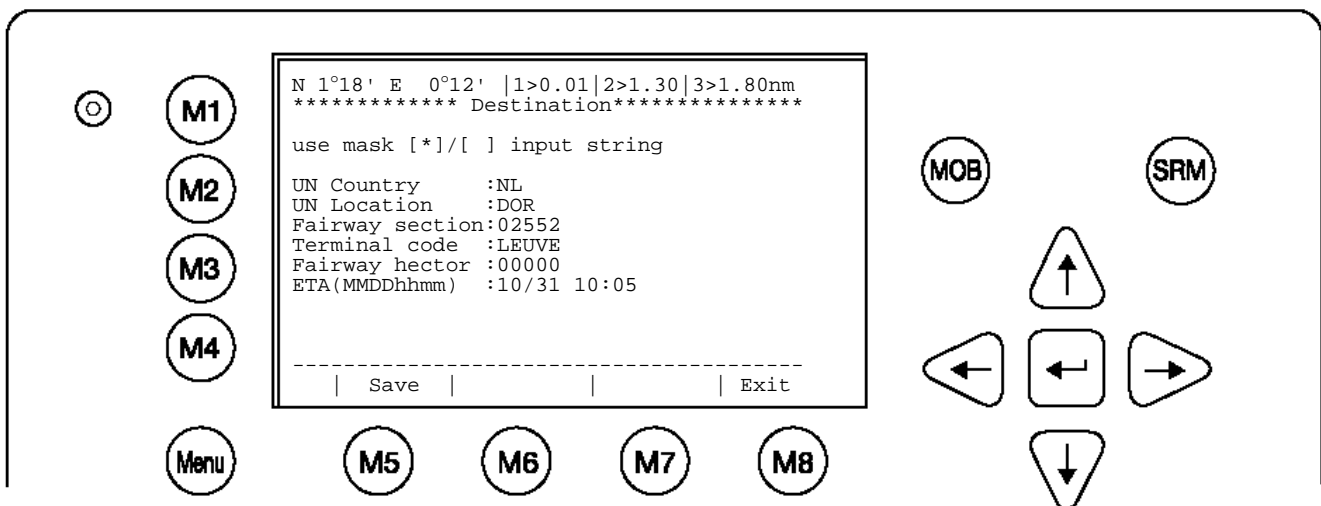

The ETA must be entered separately in the according field.

1.5 Service and User Passwords

WARNING: It is very important that the Service password not be lost. The default password from the factory is mentioned on your AIS display at the protection foil. (see Appendix 7.3 for password information). Keeping the password in a second location may be wise. Memorizing the password is best. If you lose this password, you cannot make any further configuration changes: Access to the AIS is blocked. Another master key is not available and the unit would have to be returned to the ACR Service centre. This service is not free of charge.

Once you have entered the system, please change the default password to your own passwords, for both levels of access. Use different passwords for the different security levels. Your passwords must meet the following criteria:

- Minimum of six (6) characters, maximum of eight (8) characters
- Letters must be in UPPER CASE
- Acceptable characters are the A-Z alphabet and 0- 9 digits
- Password may contain both letters and numbers

The User Password can be reset in the service configuration menu by entering the Service Configuration menu and creating a new password.

Changing the Service Password

Select “Service Configuration” from the Main Menu with the cursor button [Up] & [Down] or press Number 6 on the keyboard.

The password query field appears. Input default Service Password and press M5 [Enter].

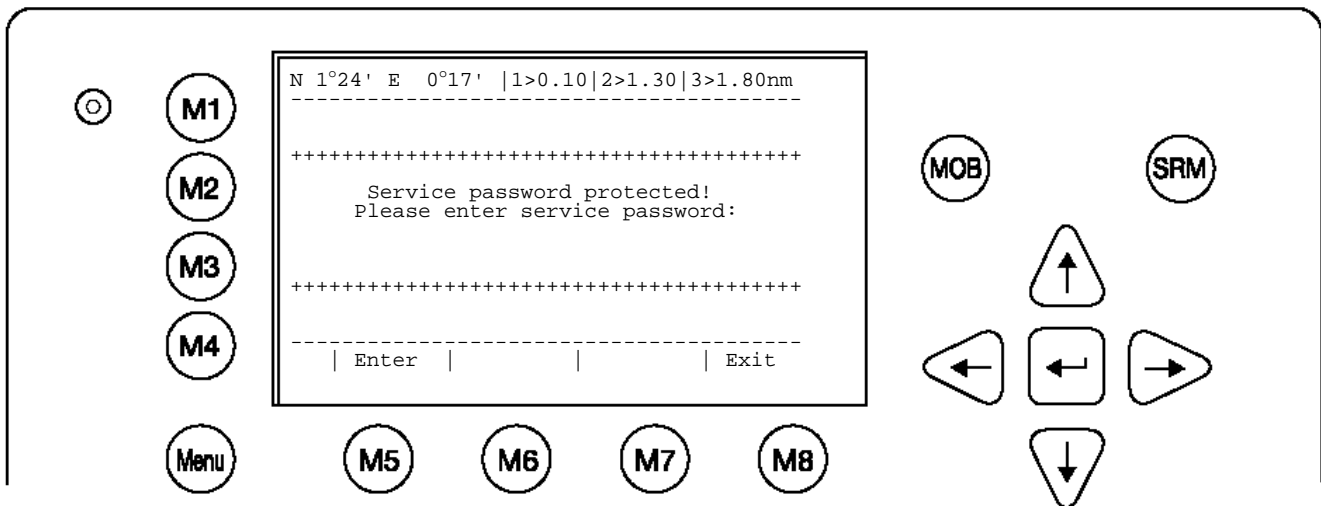

Select Submenu 1 “Change Service Password” with cursor button [Up] & [Down] by pressing Number 1 on the keyboard.

Service Menu Example:

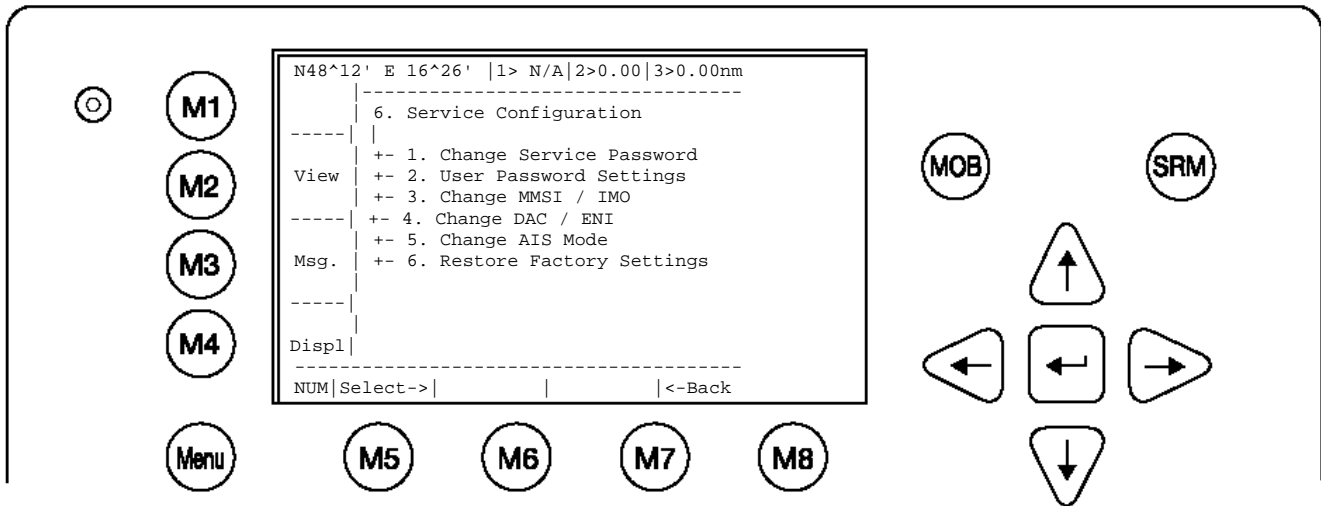

Service Password Menu Example:

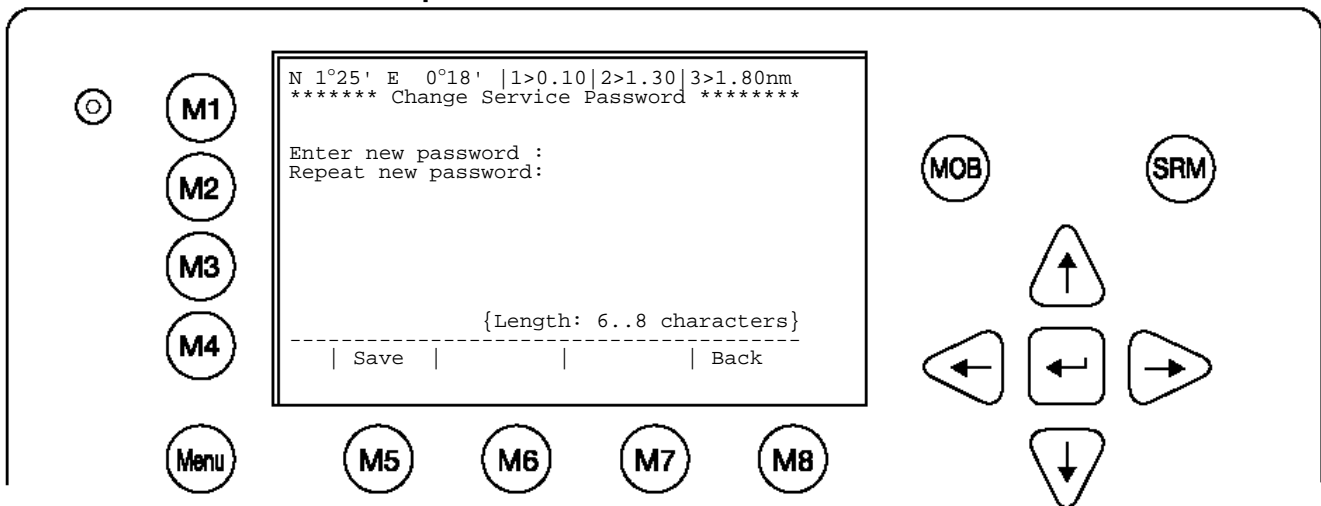

Enter the new Password: Then push Enter (M5).
Repeat the new Password: Then Push Enter (M5).

A minimum of 6, a maximum of 8 characters are allowed. Should the new password include numbers, use the shift key to generate them.

Press Save to store the change.

Changing the User Password

Select Submenu 2 “User Password Settings” with cursor button [Up] & [Down] by pressing number 2 on the keyboard.

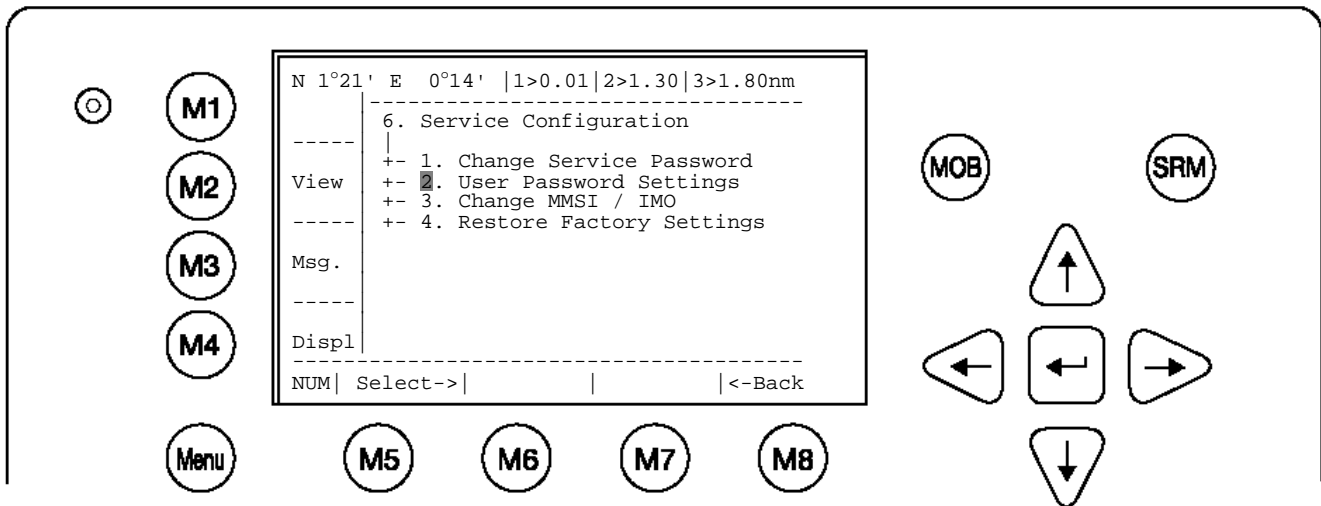

Select Submenu 1 “Change User Password” with cursor button [Up] & [Down] by pressing Number 1 on the keyboard.

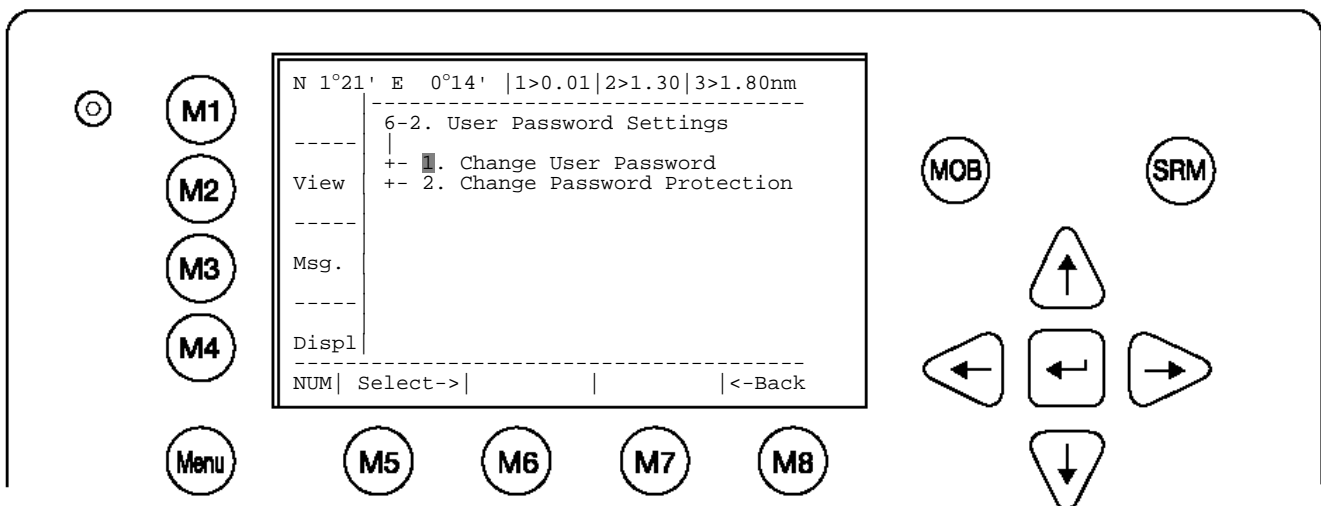

Enter the new Password. A minimum of 6, a maximum of 8 characters are allowed. Should the new password include numbers, use the shift key to generate them.

Repeat the new Password.

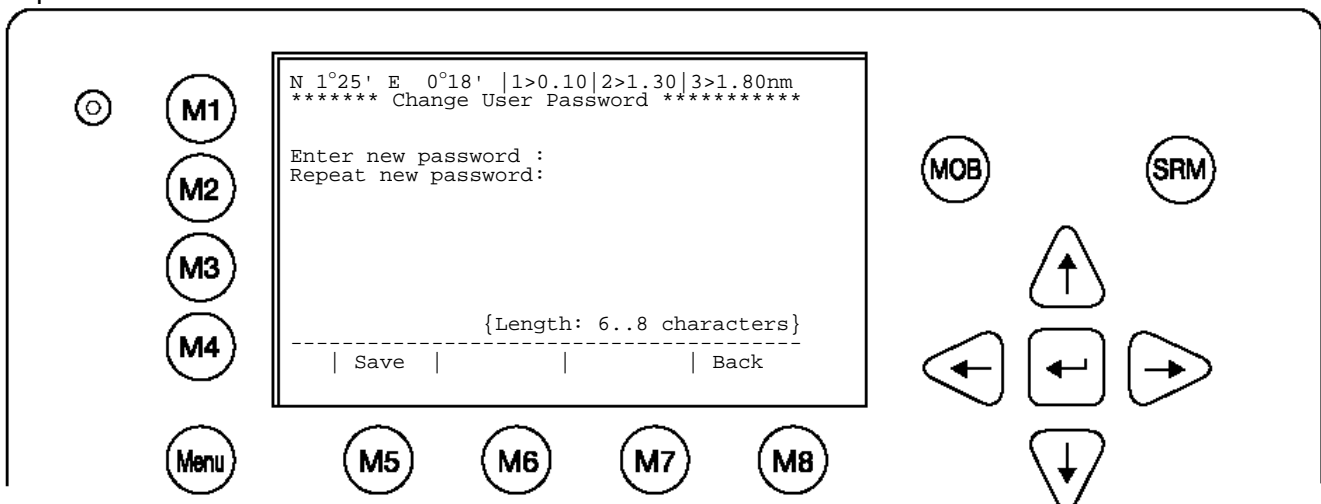

Press Save to store the changes.

2 NAUTICAST™ Inland AIS User Interface

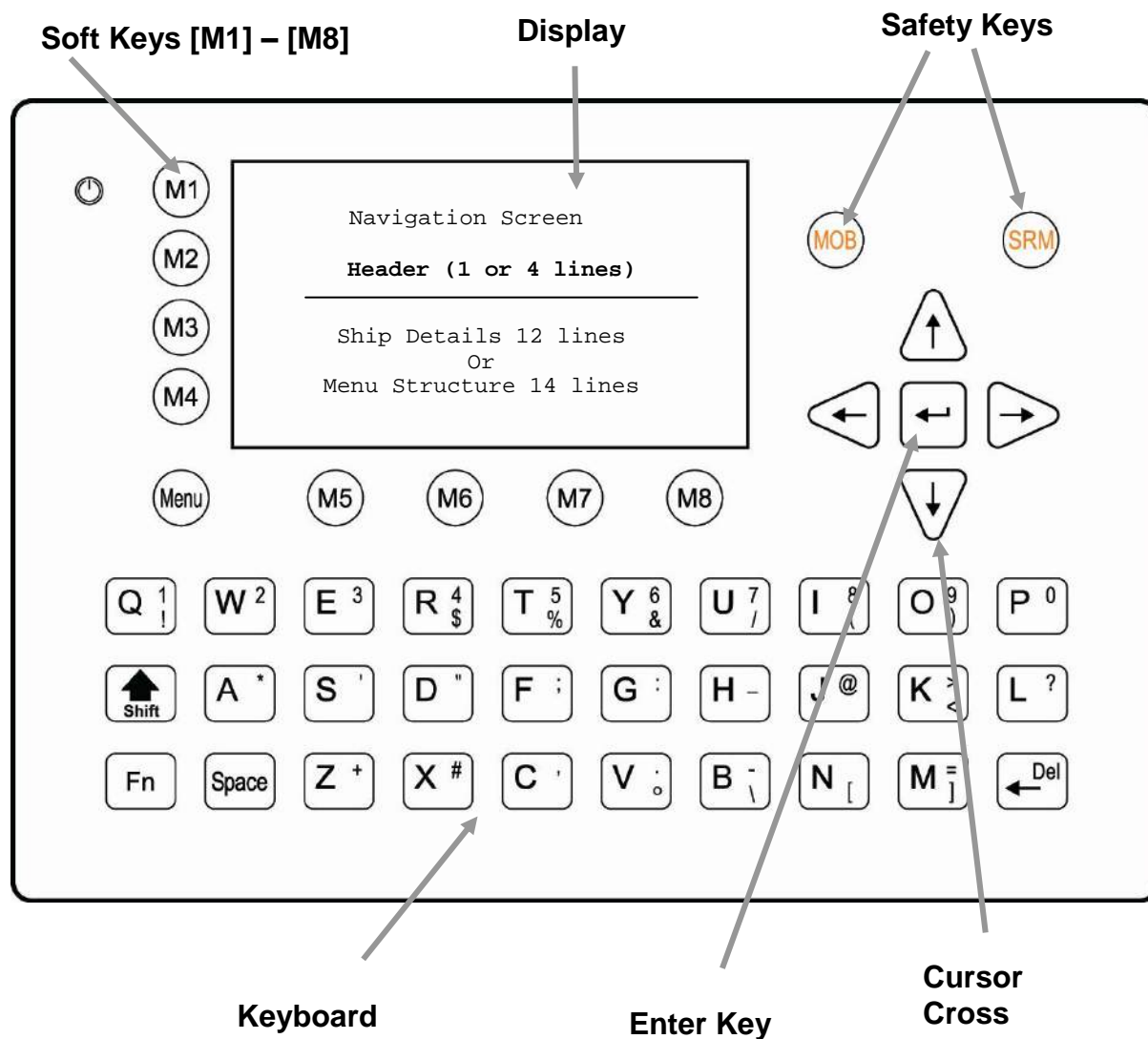

2.1 NAUTICAST™ Keyboard

The NAUTICAST™ is fitted with a full alphanumeric keyboard, with the following functions:

By pressing any key on the keyboard the letters are addressed.

Number symbols and special characters are addressed by holding down the **shift [↑]** key and simultaneously pressing the chosen key.

The characters (\$; %; &; /; (;); <; °; \; [;]) can be reached by holding down the **Function [Fn]** key and pressing the chosen key.

2.2 Explanation of the “Cursor Cross”

The Cursor Cross allows navigation within the current screen [Up] [Down] [Left] [Right].

In addition to the actually displayed [Enter] button, the center of the cursor cross always has the Enter functionality.

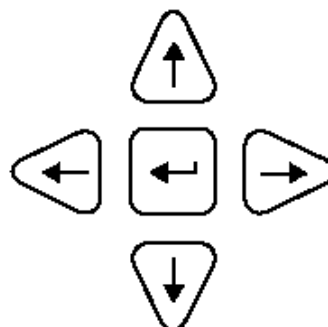

2.3 Explanation of the Num-Locked and [NUM] Functions

The NUM-Locked function is enabled after pressing the Function [Fn] Key and the Shift [⇧] Key. It is possible to disable the Num-Lock Function by pressing the Shift [⇧] Key.

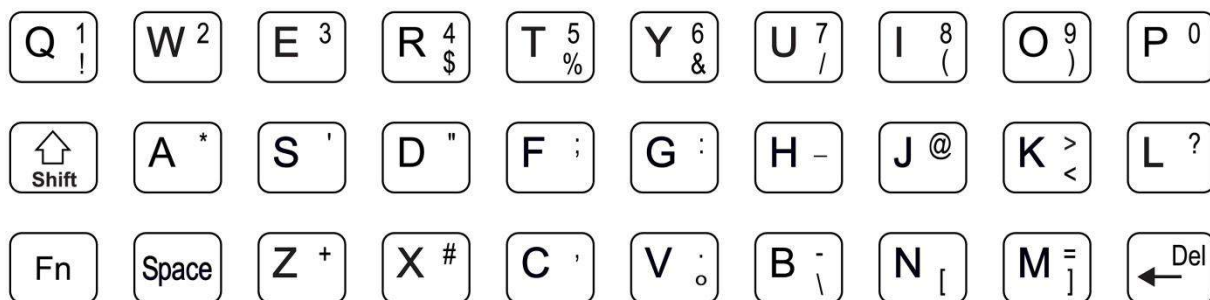

NOTE: The NAUTICAST™ automatically changes the keys “Q” through to “P” to numerical input when the current application requires numbers, rather than letters to be input. This feature is enabled when [NUM] appears on the bottom left hand side of the screen.

2.4 Explanation of the Soft Keys

The Soft Keys are divided into vertical static keys [M1-M4] and horizontal dynamic keys [M5-M8], which differ in function according to the current application.

Soft Key Definition

[M1]	filter option on AIS targets in graphical view <ul style="list-style-type: none"> • FA (hides received Class A targets) • FB (hides received Class B targets)
[M2]	Display Modes This Soft Key allows toggling between the different Display Modes.
[M3]:	Safety Message This Soft Key allows direct Message Writing. Either broadcast or addressed messages can be sent in this mode. Pending alarms could be accessed by this Soft Key
[M4]:	Display Settings - Brightness and Contrast Regulator This Soft Key allows the Display Settings to be changed between Daytime, and Nighttime Modes.
[Menu]:	Go to Main Menu or return to the Navigation View Screen.
[M5] – [M8]:	These Soft Keys are described in individual screens

2.5 Safety Keys

The NAUTICAST™ is fitted with Safety Keys, which allow the user to automatically send urgent messages without the necessity of navigating the Menus.

[MOB]	The MOB Button sends out precise position of an MOB incident to Addressed Vessels, therefore allowing the message to be sent to a vessel closest to accident location.
[SRM]	The SRM Button sends out emergency Broadcast Safety Related Messages to all ships in the Vessel Listing.

NOTE: For detailed description of the Safety Functions see Chapter 4.

3 NAUTICAST™ Screens

The advanced version of the NAUTICAST™ offers three display modes:

- Navigation Screen** - Standard screen, automatically visible
- Menu Structure** - Visible after pressing the [Menu] Soft Key
- Graphical User Interface** - The Graphical User Interface is visible after pressing the [M2] Soft Key (new mode)

3.1 Navigation Screen

This screen provides the user with Navigation Data from their own vessel and lists all other vessels within receiving range. This screen automatically appears after a period of 60 seconds of user inactivity on the Transponder.

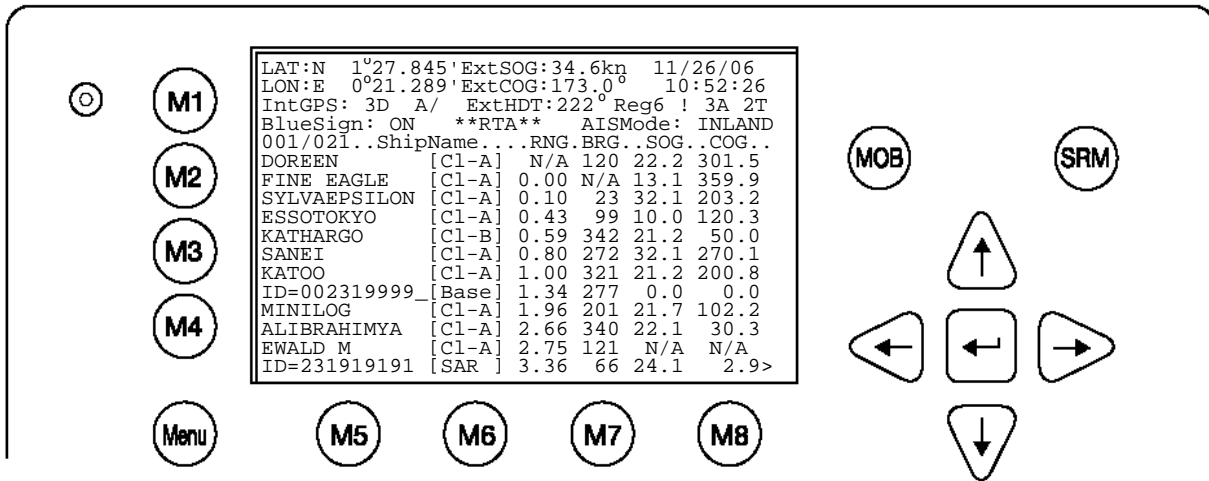

Dynamic Keys: Navigation Screen			
[M5]	Select desired vessel for Vessel Details	[Up] / [Down]	Scroll Vessel Listing Pages
[Enter]	Select desired vessel for Vessel Details	[Left] / [Right]	Scroll Vessel Listing Pages

Lines 1 – 4 of the Navigation Screen represent your own vessels data (display Latitude and Longitude, Speed Over Ground, Course Over Ground, Heading, Date and the UTC). After line 5, all data refers to other vessels within receiving range.

3.1.1 Own Vessel Data

LAT:N	1°27.845'	ExtSOG:34.6kn	05/26/06
LON:E	0°21.289'	ExtCOG:173.0°	10:52:26

LAT:	Latitude
LON:	Longitude
Date:	The actual UTC - date (MM.DD.YY) and time (hh.mm.ss) are displayed on the top right hand corner of this view.
IntGPS: 3D A/ ExtHDT:222° Reg6	
IntGPS	Indicates normal or differential mode of GPS position. 2D or 3D: Indicates the precision of the GPS result. Indicates the used position source: intGPS. = internal GNSS receiver extGPS = external GNSS receiver (sensors)
A/B: (A or B)	Indicates the last transmitting channel in use.
ExtHDT	True Heading
Reg:	Indicates the actual region of own vessel's position. If no region number is displayed, then the vessel is traveling on high sea and is outside a predefined region.

Message (SRM) Indication

LAT:N	1°27.845'	ExtSOG:34.6kn	*3S
Queued safety related messages, e.g. *3S are displayed in the date field (instead of the date) – in the above example 3 Safety Related (3S) Messages are queued, and await viewing and handling (acknowledgement or reply) in the Message Inbox History.			

Alarm (ALR) and Text (TXT) Indication

IntGPS: 3D	/B	Reg6	! 3A 2T
Queued alarms or messages, e.g. ! 3A 2T are displayed in the 3 rd line – in the above example 3 (3A) Alarms and 2 (2T) Text Messages are in queue, and await viewing and handling (acknowledgement and reaction).			

BlueSign Indication

BlueSign: ON **RTA** AISMode: INLAND
The "BlueSign" indication is the status of the external "Blue Sign" - switch. The Blue Sign information will be transmitted in the position message and indicated in this field. ' N/A ' means no Blue Sign available (see chapter 3.5.5 0! ' OFF ' Blue Sign is available and set to OFF. ' ON ' Blue Sign is activated!

RTA Indication

BlueSign: ON **RTA** AISMode: INLAND
The "RTA" indicates a received Requested Time of Arrival. The content of this message could be seen in the Message Menu.

Inland Indication

BlueSign: ON **RTA** AISMode: INLAND
The AIS-Mode indicator shows the actual configured mode of the NAUTICAST. The NAUTICAST could be used as INLAND AIS and as SOLAS Product.

3.1.2 Other Vessel Data

001/021..SHIPNAME....RNG.BRG..SOG..COG..	
001/021	(E.g: Vessel 01 of 021) current or selected Vessel/ Total number of Vessels (max. 256 Vessels)
ShipName:	Name of the Ship and AIS – Type: CI-A: SOLAS Class-A Ship CI-B: Leisure Craft Base: Base station SAR : Search and Rescue Aircraft
RNG	Vessel Range Note: The vessel closest to own ship, or where position data is unknown (N/A), is listed first.
BRG	Vessel True Bearing
SOG	Speed Over Ground
COG	Course Over Ground

A maximum of 12 vessels are displayed on the screen. If more than 12 vessels are currently being received, the symbol [>] on the right bottom appears, indicating that there are further vessels to be seen in the Vessel Listing. By pressing the [Right] key, it is possible to scroll to the next page for further Vessel Listing, by pressing the [Left], the user scrolls back to the previous page.

Further details on any individual vessel can be obtained by scrolling down and selecting the desired vessel by pressing [Enter]. A full explanation of the Vessel Details is given in the following section.

3.1.3 Short Header

A constant overview of the most important AIS navigation details, including own position and distance of the three closest vessels is always displayed the first line. This information appears in every Submenu and is called the “Short Header”.

N 1°21 E 0° 14' 1>0.10 2>1.30 3>1.80nm
Own Vessel Position: N 1°21' E 0°14'
1> Closest vessel situated 0.10 nm away
2> Second closest vessel situated 1.30nm away
3> Third closest vessel situated 1.80nm away

3.1.4 Other Vessel Details

This screen shows the Dynamic, Voyage and Vessel Related Data, which is currently being transmitted by a previously selected vessel.

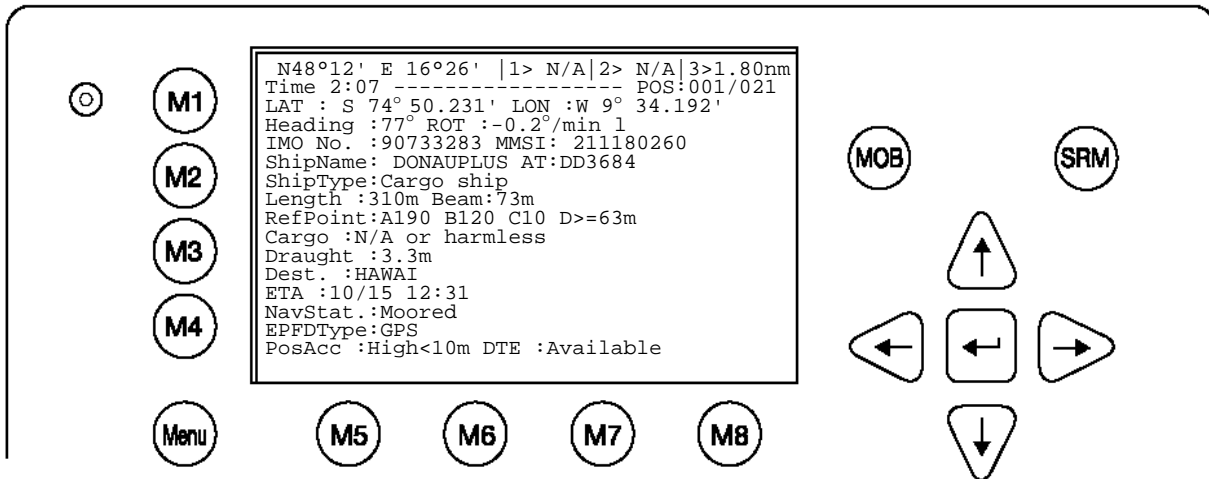

Current Time and Selected Vessel Number in Vessel Listing:

Time 2:07 ----- POS: 0001/0021
Time: The period of time which has elapsed since the last update is shown in minutes and seconds. The update rate differs according to the respective vessels speed.
POS: Indicates the number of the selected vessel (e.g. vessel 02 of 21) from the Vessel Listing and the total number of vessels being received.

Position of the selected vessel:

LAT : S74°50.231' LON : W 9° 34.192'

Heading and Rotation of the selected vessel:

Heading :77° ROT :-0.2°/min l

IMO-Number and MMSI of the selected vessel:

IMO No. : 90733283 MMSI: 211180260

Name and ATIS code of the selected vessel:

ShipName: DONAUPLUS AT: DD3648

Vessel Type: IMO – ship type (high sea)

Cargo ship

Length and Beam of the selected vessel: Complete convoy

Length:310m Beam:73m

Reference Point (in meters):

This information indicates the Reference Point of the used GPS Antenna onboard the vessel.

RefPoint:A190 B120 C10 D<63m

- A: 190m
- B: 120m
- C: 10m
- D: >63m (means more than 63m in the case of a very large vessel)

Vessels Cargo:

Indicates the type of cargo on board.

N/A or harmless

Further Vessel Details:

Draught : 3.3m

Dest : HAWAII

ETA : 10/15 12:31

NavSt : Moored

Information on the vessel's Equipment Position Finding Device:

EPFDType: GPS

Position Accuracy and Data Terminal Equipment (DTE):

PosAcc :High <10m

DTE :Available

This information indicates that the vessels Transponder is connected with a user interface and can show AIS Data. This function basically ensures that the current Transponder being used is fitted with a display and can therefore send and receive messages. As the NAUTICAST is fitted with an integrated display unit, it will always show "DTE: Available".

Press [Enter] for more details in next view:

Additional Inland Vessel details:

European Vessel Identification Number (ENI):

ENI : 04401020

Blue Sign: N/A means ship do not have a Blue Sign

Blue Sign: N/A

Additional Inland Vessel dimension and information:

Length: 27.5m	Beam: 5.5m
Draught: N/A	
Convoy: 8490 - Bunkership [ERI Ship Type]	
Load: unload	Hazardas: N/A
Quality: Speed: Lo	Course: Lo Heading: Lo
Persons on Board:	
Crew: 2	Support: 1
Int'l: 4	Passengers: 1

3.2 Menu Structure

To call up the Main Menu, press the [Menu] button once, and all Submenus are displayed. The cursor position indicates the selected submenu.

Menu navigation is achieved by pressing the [Up] or [Down] keys to select, and then by pressing [Enter] to confirm the desired Submenu selection.

To escape from any Submenu and returning to the Navigation Screen, press the [M2] button at any time.

The own vessel's current Navigation Information is continuously displayed on the first line. It contains the own position and the first three vessels, which are located within closest range of the own ship.

Tip: Fast Menu Selection is achieved by simply pressing the desired Submenu Number on the keyboard.

3.3 Main Menu

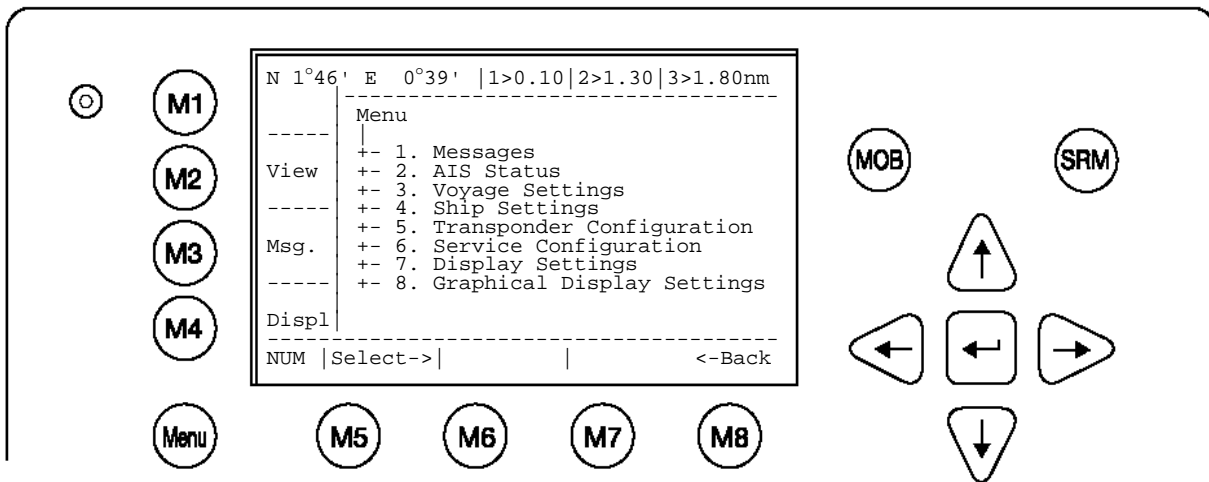

Dynamic Keys: Main Menu Screen				
[M5]	[Select]	Select chosen Submenu	[Enter] or [Right]	Confirm Submenu Selection
[M8]	[Back]	Return to Navigation Screen	[Up] / [Down]	Navigate Submenu for selection

NOTE: The navigation screen automatically appears after some seconds of user inactivity on the transponder, or immediately by pressing the [Menu] button in the Main Menu.

3.4 Sub-Menus Overview Messages

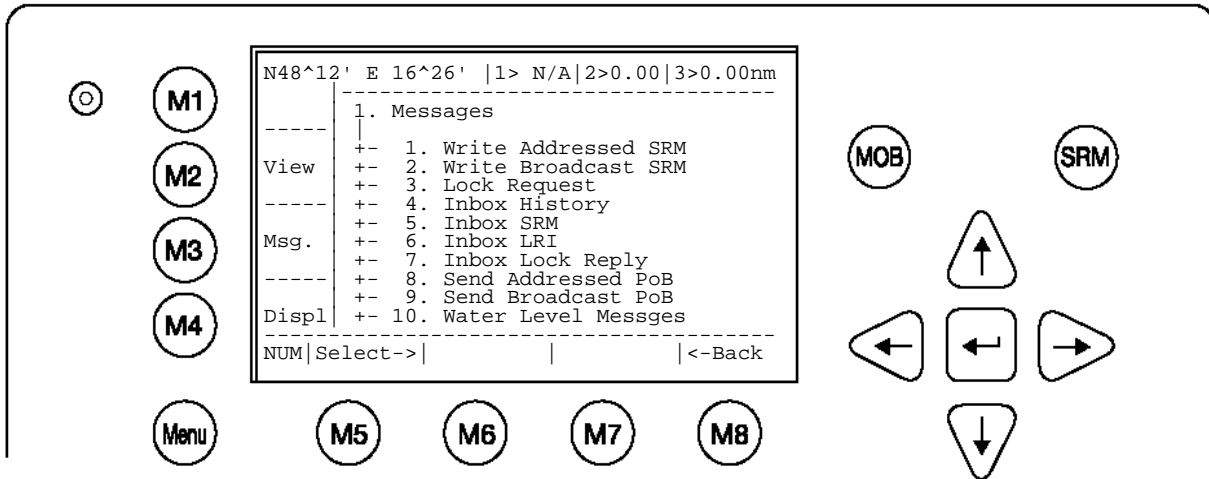

3.4.2 AIS Status

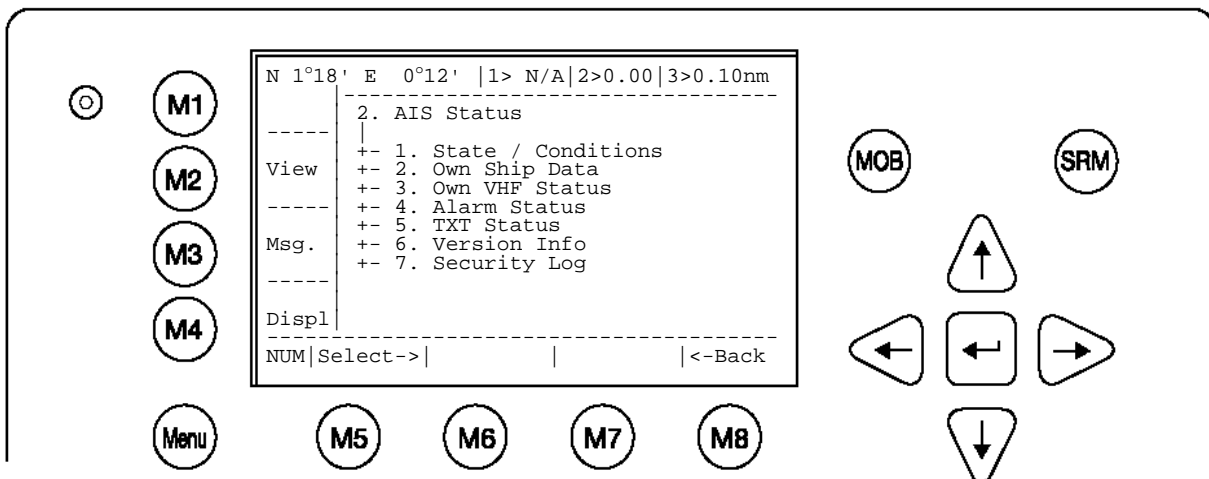

3.4.3 Voyage Settings – (User Password Protected)

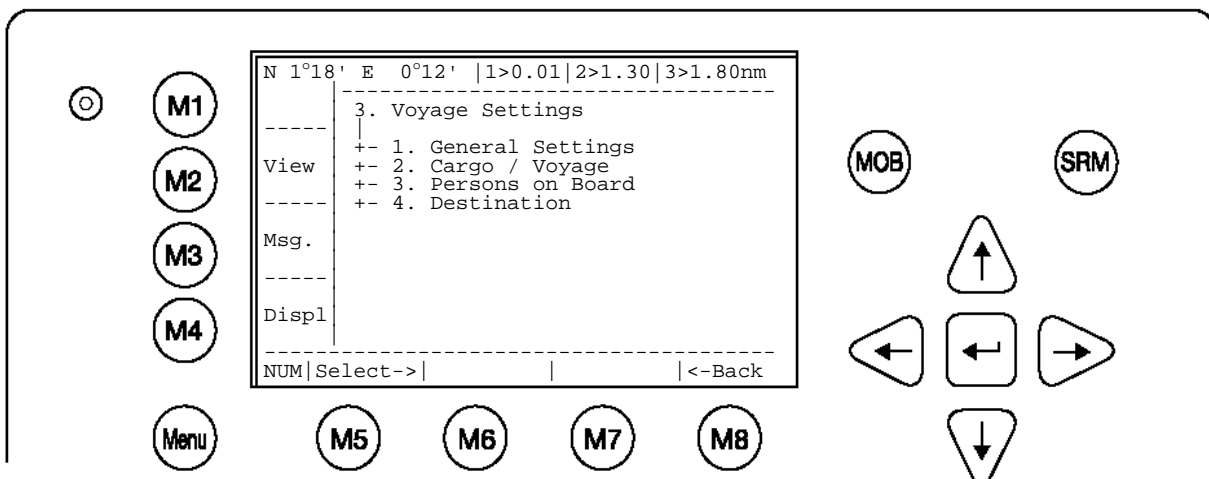

3.4.4 Ship Settings – (User Password Protected)

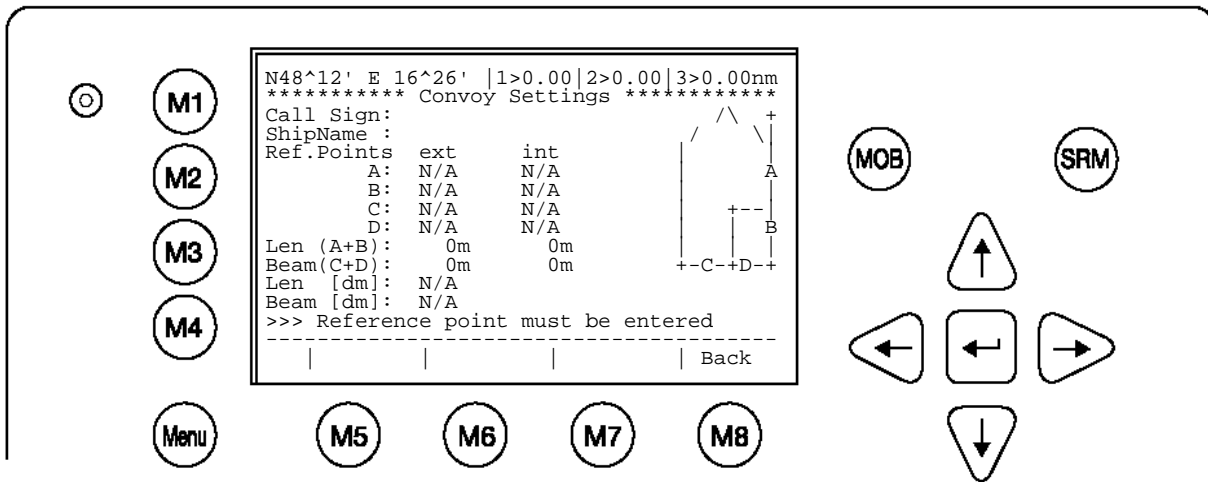

3.4.5 Transponder Configuration – (User Password Protected)

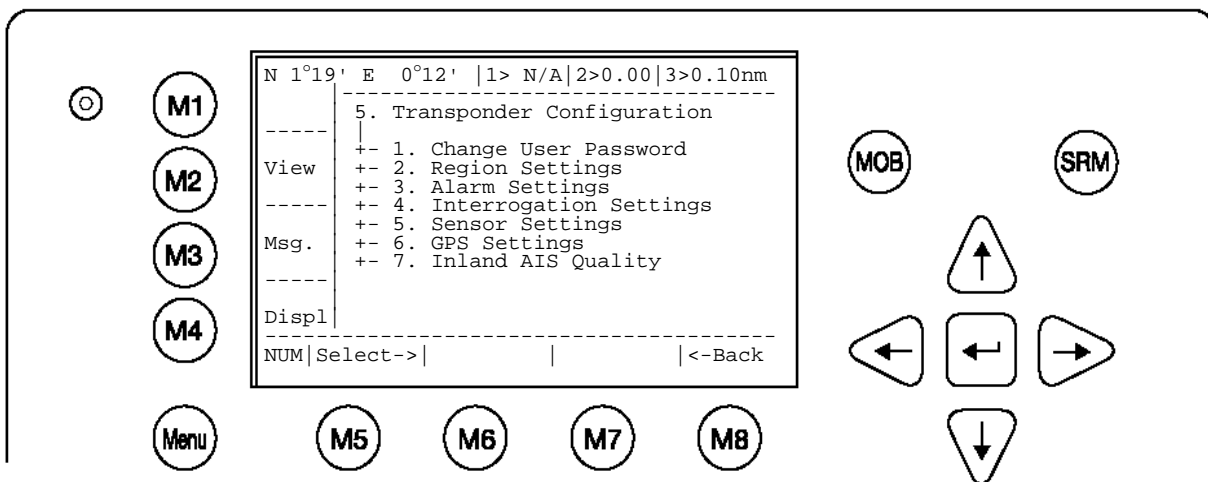

3.4.6 Service Configuration – (Service Password Protected)

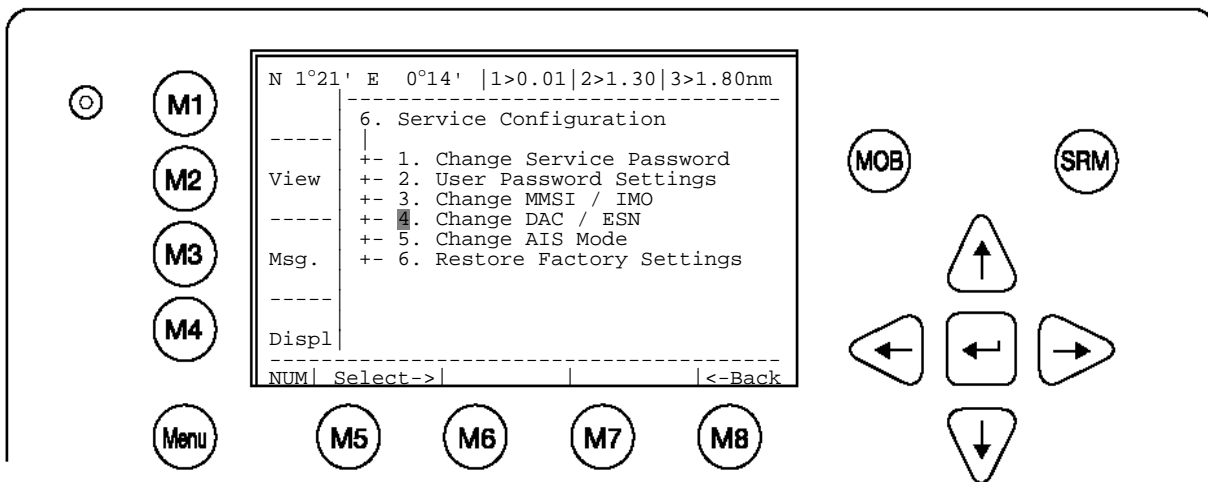

3.4.7 Display Settings

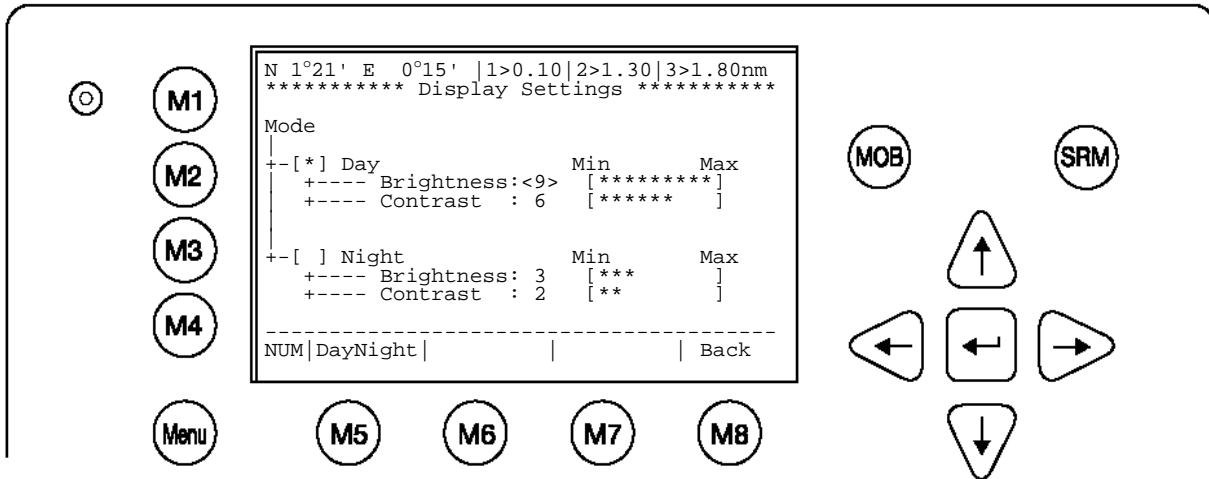

3.4.8 Graphical Display Settings

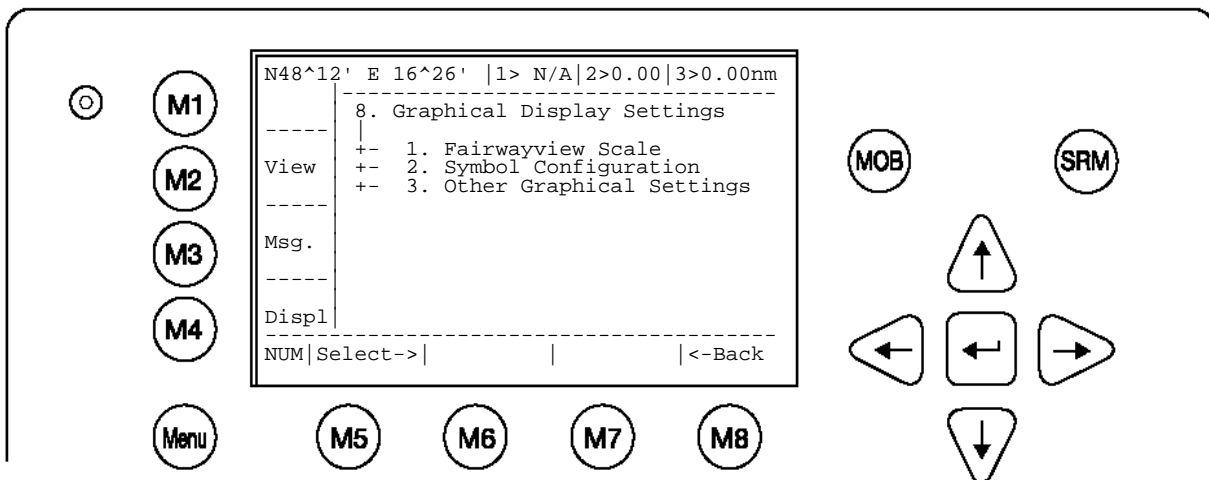

3.5 Sub-Menus Detailed

3.5.1 Messages

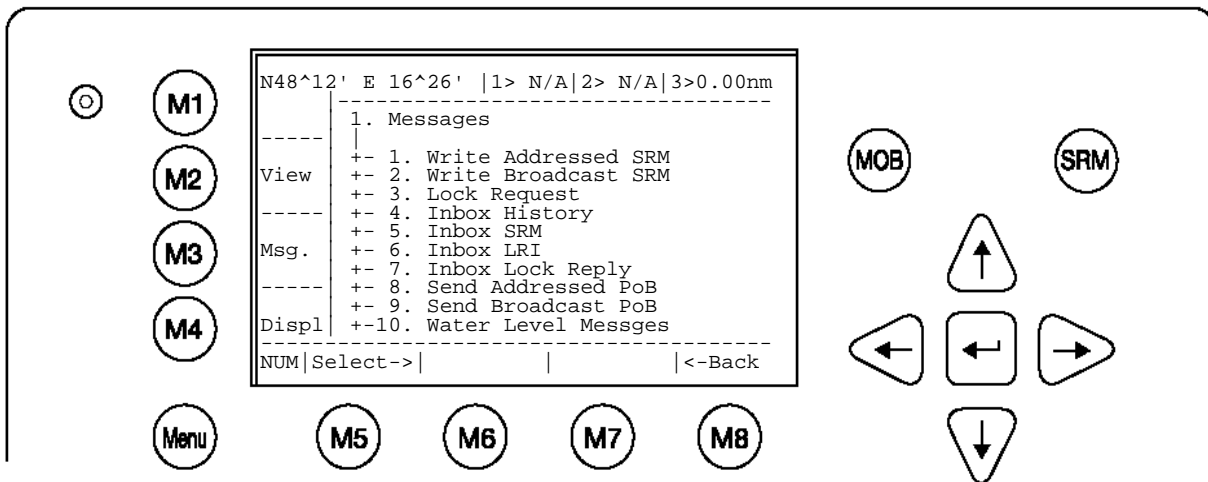

Dynamic Keys: Messages					
[M5]	[Select]	Select Submenu	chosen	[Enter]	Confirm Submenu Selection
[M8]	[Back]	Return to Main Menu Screen		[Up] / [Down]	Navigate Submenu for Selection

Writing Messages:

This screen provides a means to write and send messages.

It is possible to select between an Addressed Message to a single selected vessel, and a Broadcast Message, which is sent out to all vessels in the current Vessel Listing.

Message Inboxes:

The Inbox History gives an overview of all incoming messages. The Inboxes are further divided into four sections, allowing the user to see, and act upon specific Message Types.

- 3.5.1.1 Inbox History:** Overview of all Messages, Alarms and LRI Interrogations
- 3.5.1.2 Inbox SRM:** Listing all Safety Related Messages (SRM)
- 3.5.1.3 Inbox LRI:** Listing of all Long Range Interrogations (LRI)
- 3.5.1.4 Inbox Lock Reply:** Listing of Lock Replies
- 3.5.1.5 Interrogate IFM:** Inland message interrogations

Message Storage Capacity:

The Inbox History has the capacity to store a total of 60 messages. The older messages are automatically deleted, when the respective Inbox has reached its maximum storage capacity.

Message Type:

Addressed or Broadcast Messages (SRM):
Alarms (ALR):
Long Range Interrogation (LRI):

Maximum Storage Capacity:

Latest 30 Messages stored
Latest 20 stored
Latest 10 stored

a) Writing an Addressed Message

To write a Safety Related Message first select an addressee from the Vessel Listing. This is possible by using the cursor buttons [Up] and [Down], and confirming the selection with [Enter] or [Select].

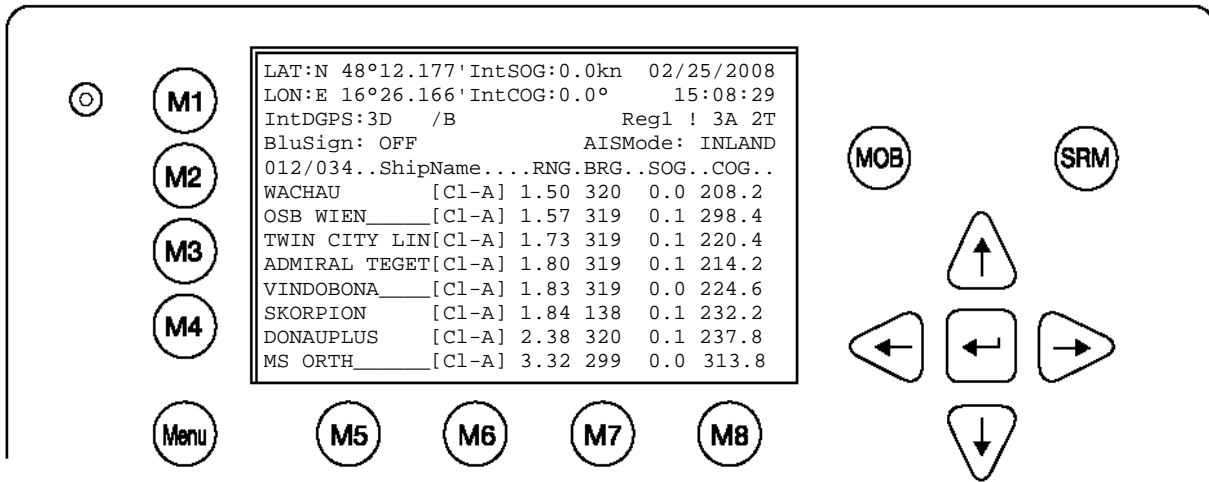

Dynamic Keys: Messages				
[M5]	[Select]	Write Message to Selected Vessel	[Enter]	Write Message to Selected Vessel
[M8]	[Back]	Return to Messages Menu		

b) Using the NAUTICAST™ Message Editor

After selecting a vessel, the Message Editor is automatically displayed. Messages containing a maximum of 156 characters are allowed. Longer texts require a second message. After text input completion, transmission to the selected addressee is facilitated by pressing the [Send] button. The [<Back>] button leads to the Message Editor for writing a second message to the same addressee. A second activation of the [<Back>] button leads to the Vessel Listing and allows selection of another addressee.

It is possible to select the desired channel by pressing the [<Channel>] buttons. The default setting for Addressed Messages is (auto) in contrast to Broadcasted Messages, where the default setting is set at Channels A+B (AIS1 + AIS2).

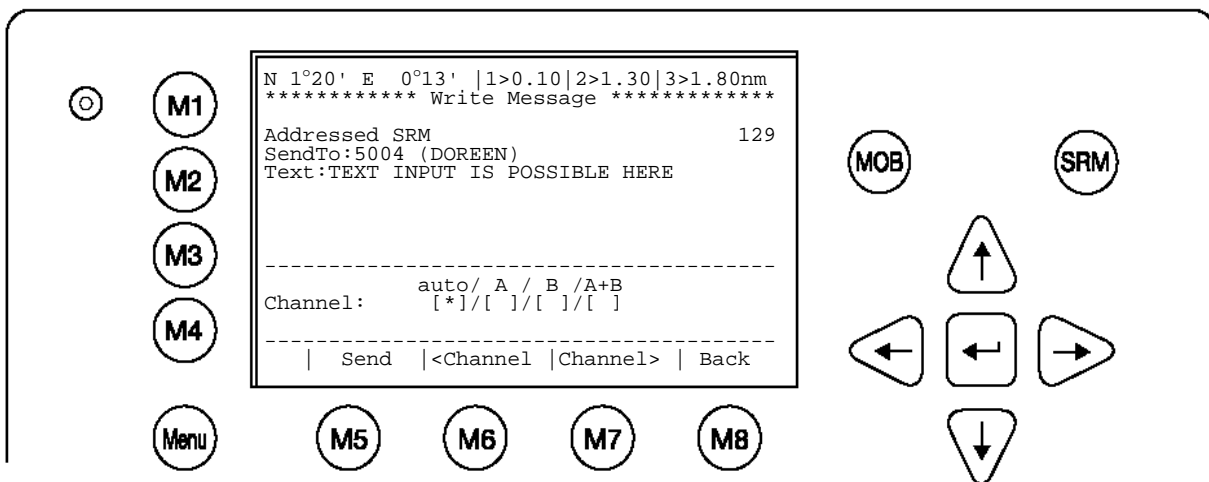

Dynamic Keys: Addressed Message Editor				
[M5]	[Send]	Send Message	[Enter]	Send Message
[M6]	[Channel]	Select Transmission Channel		
[M7]	[Channel]	Select Transmission Channel		
[M8]	[Back]	Return to Vessel Listing		

c) Confirmation of Sent Addressed Message

The confirmation screen shows the successful message transmission and indicates which channels (AIS1 or AIS2) were used.

Successful Message Transmission on Channel AIS1:

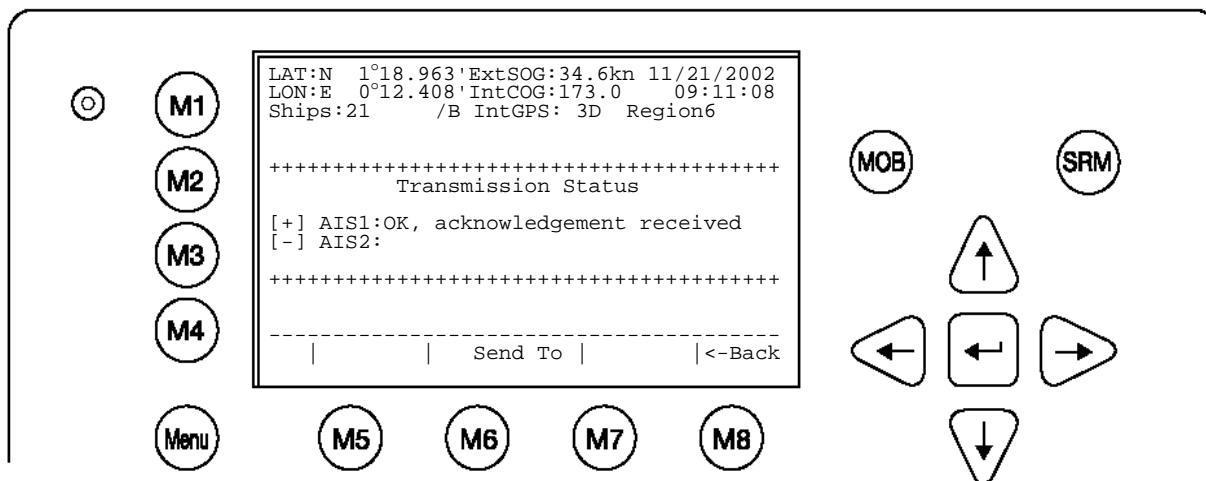

In some cases, the recipient's Transponder may not be able to receive the message immediately – due to Transponder in-operation. In this case, the confirmation of the send message arrives later, upon Transponder re-operation.

Successful Message Confirmation (late reply):

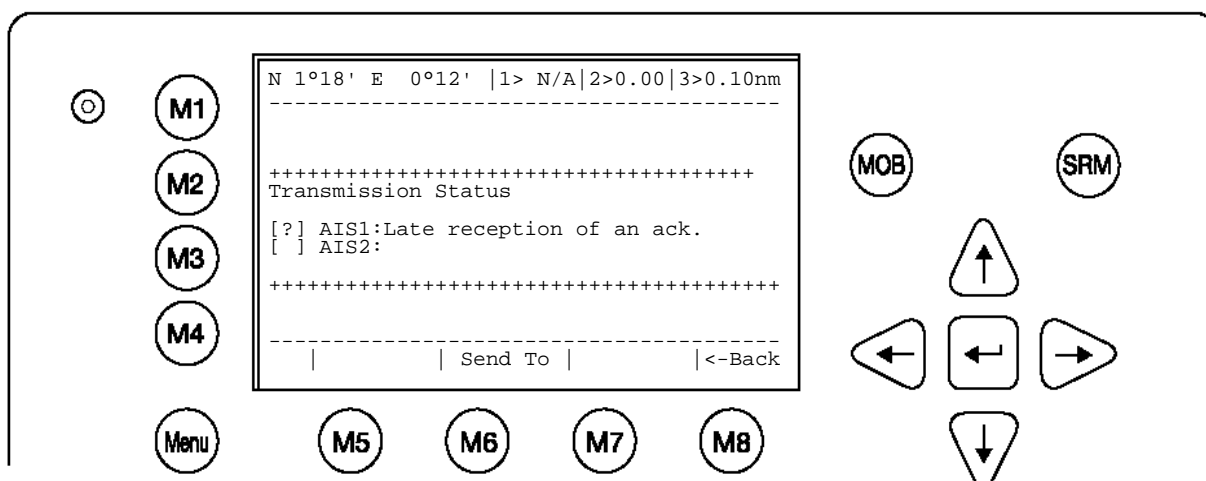

It is possible, that the recipient's Transponder could not receive the message at all, and in this case the following screen is displayed. It is then recommended to resend the message.

Unsuccessful Message Confirmation (no acknowledgement)

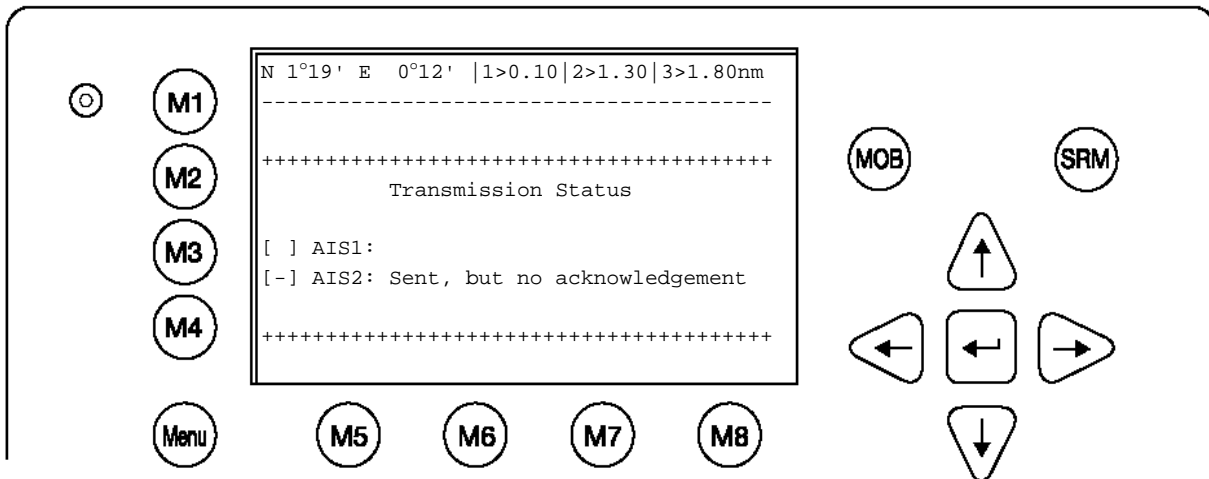

d) Writing a Broadcast Message

Upon selection of Write Broadcast SRM in the Message Menu, the Message Editor appears. Messages containing a maximum of 161 characters are allowed. Longer texts require a second message. When the text input has been completed, transmission to all vessels within receiving range is possible by pressing the [Send] button. The [<Back] button leads to the Message Editor.

It is possible to select the desired channel by pressing the [<Channel>] buttons. The default Settings for Broadcasted Message Setting is A+B (AIS1 and AIS2).

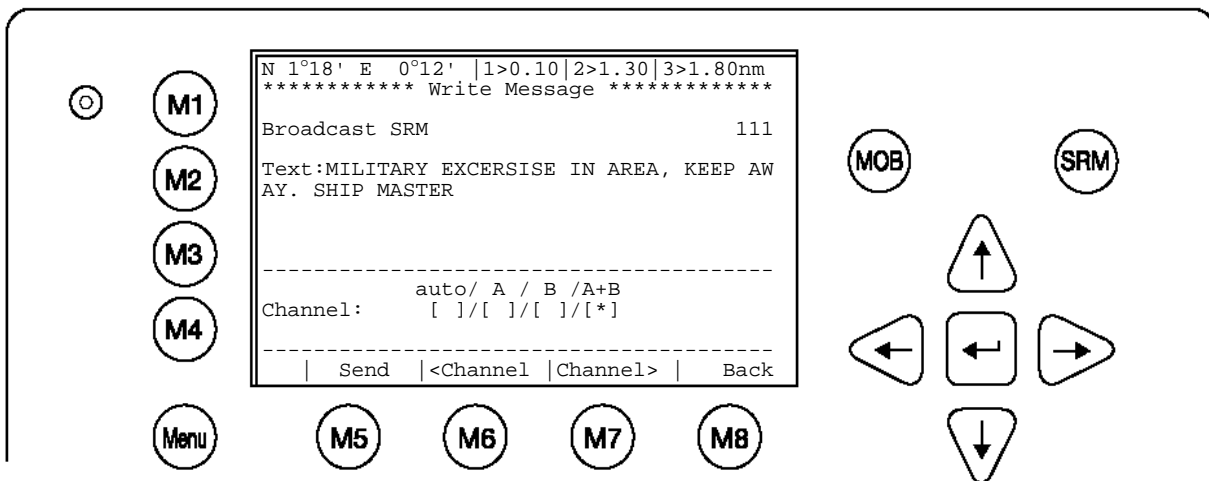

Dynamic Keys: Broadcast Message Editor				
[M5]	[Send]	Send Message	[Enter]	Send Message
[M6] [M7]	/ [Channel]	Select Transmission Channel (A+B is default)		
[M8]	[Back]	Return to Messages Menu		

e) Confirmation of Broadcast Sent Message

This Confirmation Screen shows that the message was successfully transmitted on the Broadcast Setting. By pressing [Back] the user automatically returns to the Message Editor for further Messaging. The [SendTo] returns the user to the Vessel Listing, with the option of further Message Writing to individual vessels.

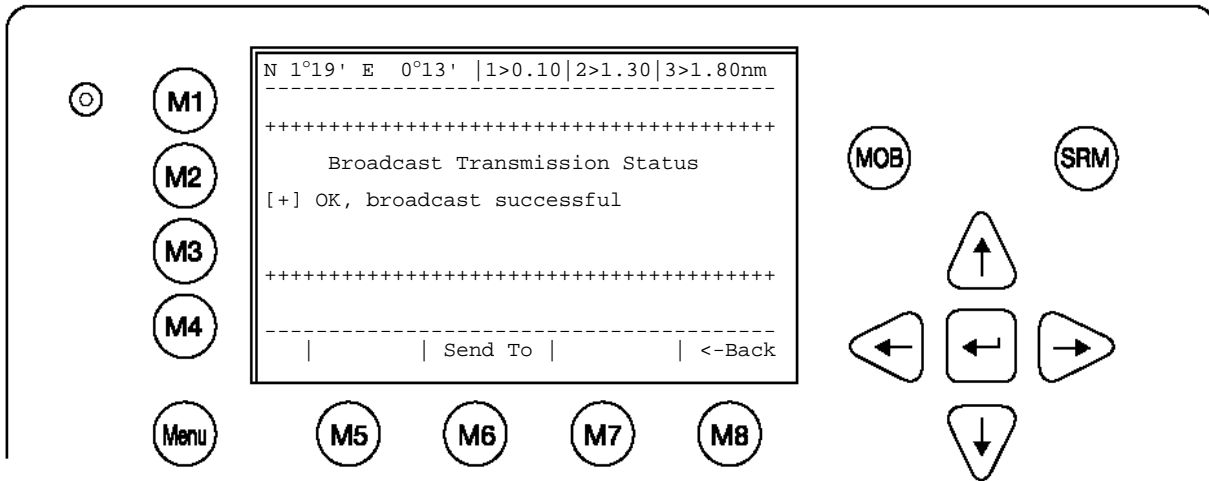

In the case of failed transmission, the following screen appears. In this case, it is recommended to retransmit the Broadcast Message.

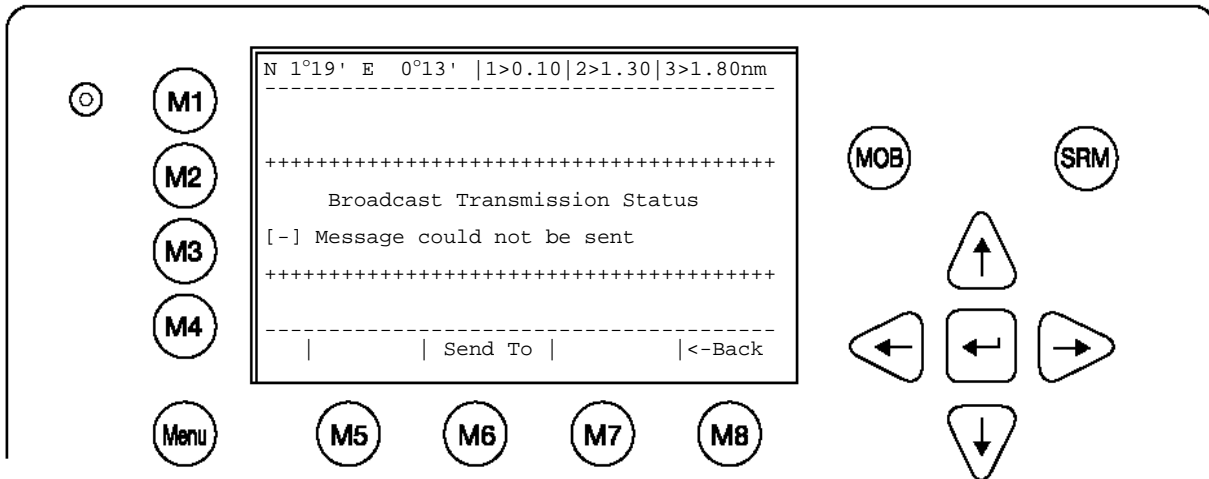

f) Long Range Interrogation

Mobile, and shore-based stations have the ability to interrogate vessels and make requests for information over the “Long Range Interface”. The interrogated vessel can either reply in automatic, or in manual mode. The interrogation request is displayed in both modes.

The arrival of a Long Range Interrogation Request is indicated by:

1L on the top right hand corner of the Navigation Screen. The LRI automatically arrives in the Message Inbox LRI and can be handled from there.

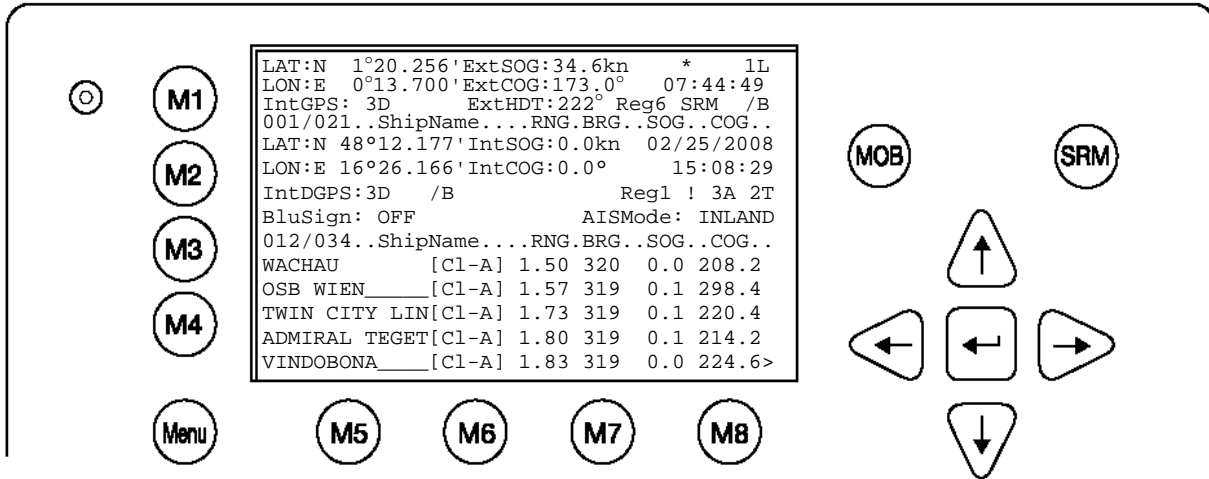

Handling a Long Range Interrogation (LRI)

Default Settings for LRI Requests:

Automatic Mode: The LRI is automatically dealt with and own vessel data is sent.

Manual Mode: The LRI needs to be manually handled.

NOTE: The data which may be interrogated via the Long Range Interface can be configured in Menu 5: Configuration, Submenu 5: Interrogation Settings.

An LRI has arrived;

The NAUTICAST™ Settings are configured to **Automatic Mode:**

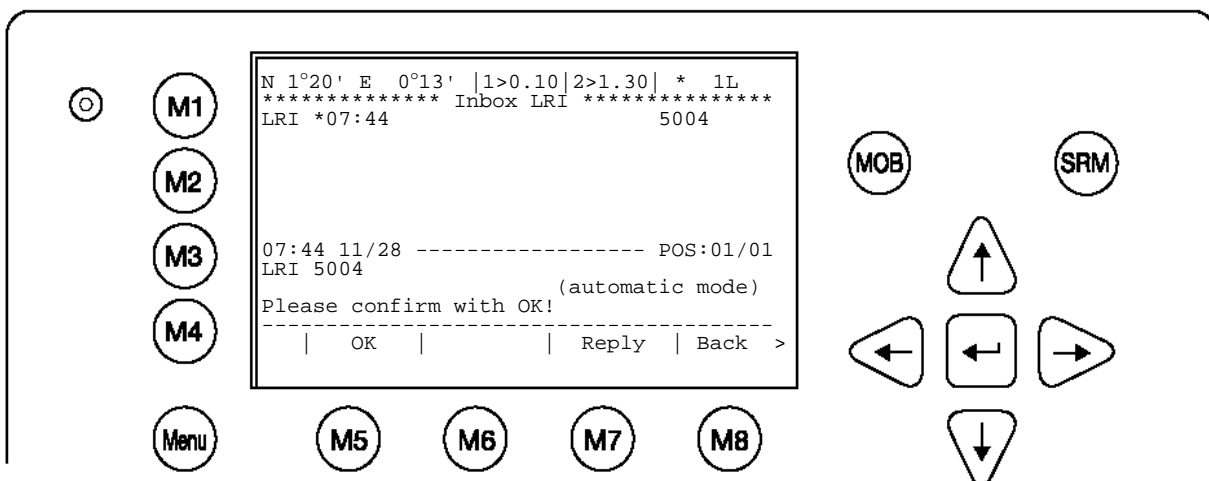

Dynamic Keys: LRI in the Inbox History (automatic mode)					
[M5]	[OK]	Confirms that LRI has been seen	[M8]	[Back]	Return to Message Menu
[M7]	[Reply]	Send Addressed Message to LRI sender			

Upon activation of the [OK] button, the user confirms that he has been notified of a current Transponder system interrogation. This information is useful, as it prevents unknown interrogation from taking place when the transponder is set in automatic mode.

Upon pressing the [Reply] button, user returns to the Message Editor from where it is possible to send an addressed message to the LRI sender.

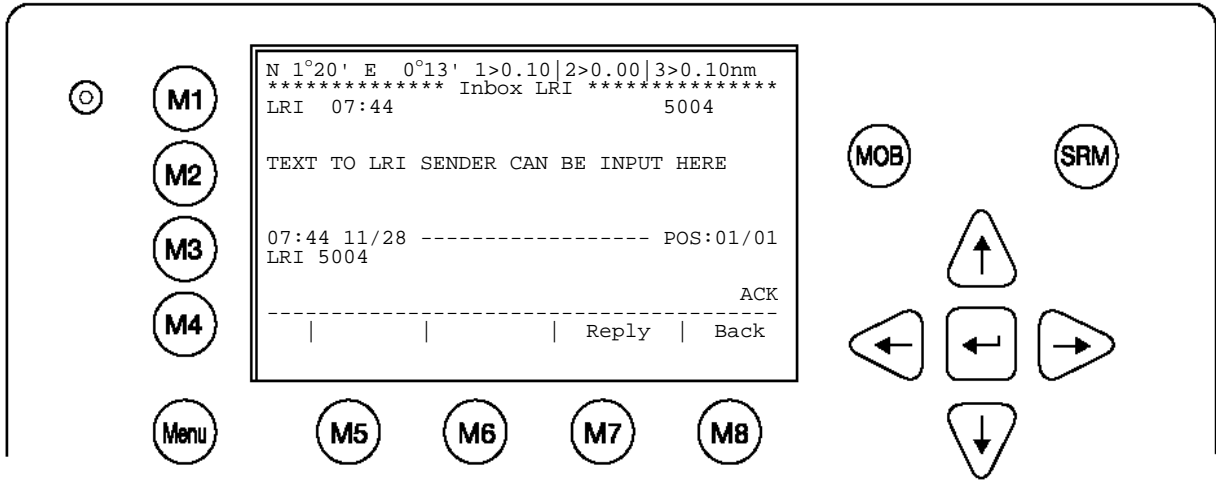

An LRI has arrived; the NAUTICAST™ Settings are configured to **Manual Mode**:
The LRI therefore needs to be manually handled (accepted or rejected)

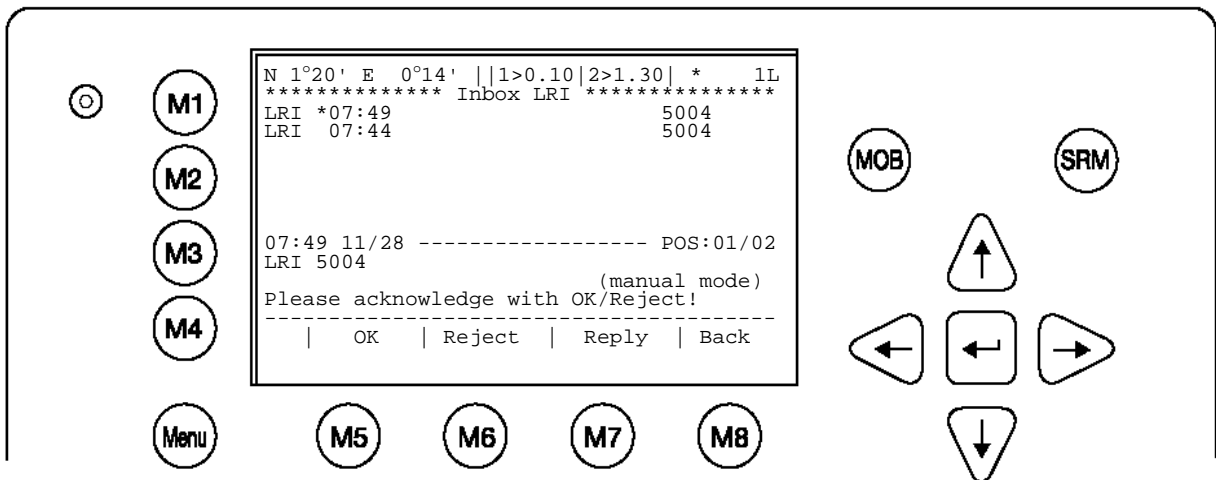

Dynamic Keys: LRI in the Inbox History (manual mode)					
[M5]	[OK]	Accept Interrogation LRI	[M7]	[Reply]	Send Addressed Message to LRI Sender
[M6]	[Reject]	Reject Interrogation LR	[M8]	[Back]	Return to Messages Menu

g) Inbox History

The Inbox History provides a means to reading incoming messages and alarms. The messages are listed in chronological sequence. The message type (SRM, ALR or LRI), Status, Time, Message Text Preview and MMSI Number of sender are shown in this overview screen.

To select a message navigate with the cursor [Up] or [Down] – the selected message text is displayed in the text field. The [Back] button takes the user to Messages Menu.

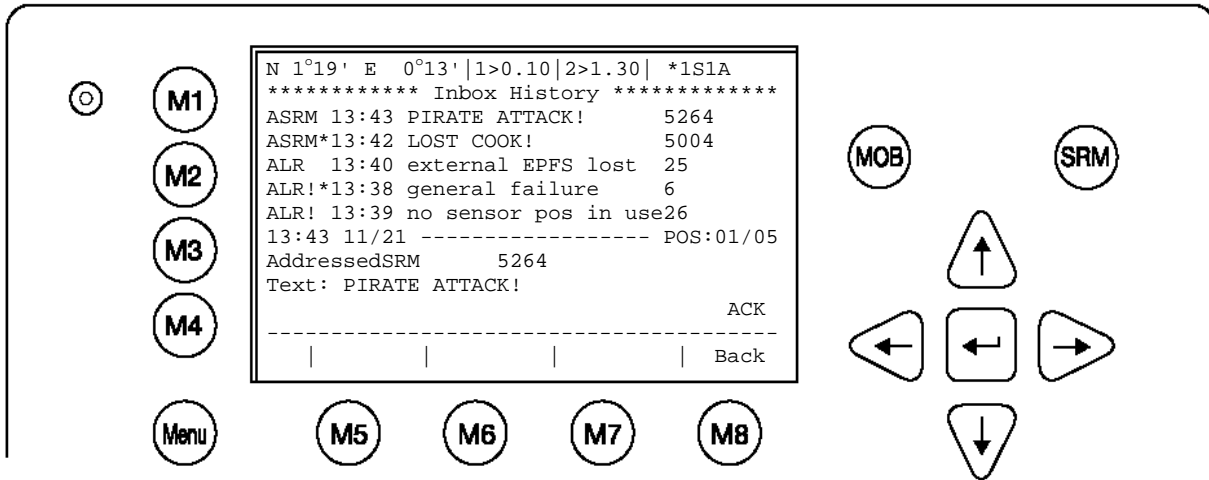

Inbox History: Overview of Received Messages and Alarms	
Message Types:	Description
ASRM	Addressed Safety Related Message
BSRM	Broadcast Safety Related Message
ALR	Alarms (Details – see Alarm Types)
LRI	Long Range Interrogation
Message Status:	
*	Marks a new, unacknowledged message or alarm
!	Marks a valid alarm requiring action
[]	Marks a revoked alarm (no longer active)
ACK (Acknowledged)	Abbreviation, which is displayed on bottom right hand corner and signifies that selected message or alarm, has been previously acknowledged.

Inbox History: Message and Alarm Types and Status Definition:

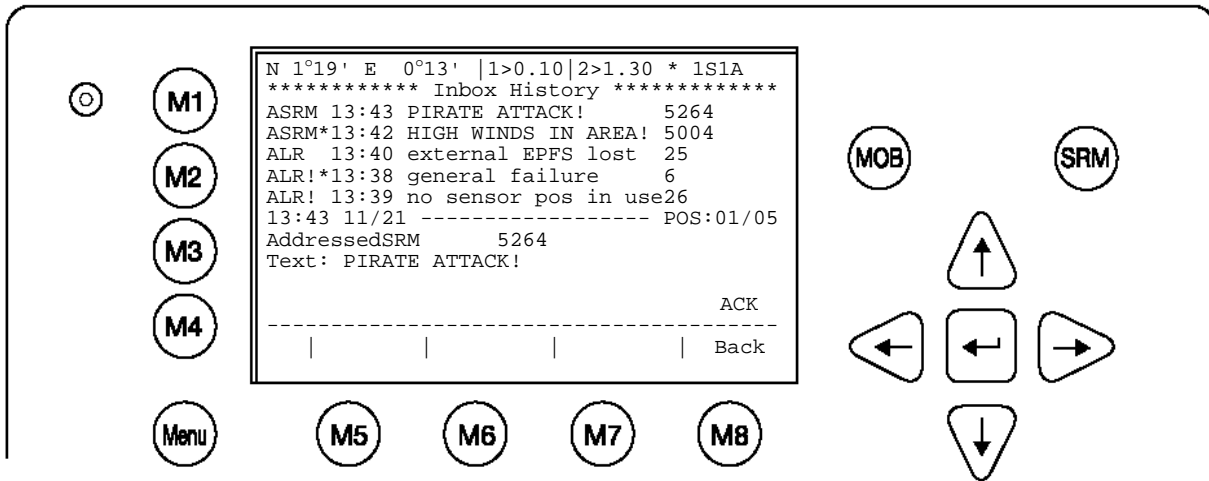

ASRM 13:43 PIRATE ATTACK! 5264

Addressed Safety Related Message, acknowledged by recipient, arrived at 13:43, with text "Pirate Attack", from vessel with MMSI 5264

ASRM*13:42 HIGH WINDS IN AREA! 5004

Addressed Safety Related Message, unacknowledged by recipient, arrived at 13:42, with text "High winds in area!" from vessel with MMSI number 5004

ALR 13:40 external EPFS lost 25

Alarm, no longer active (revoked) with ID Number 25 (see Alarm Types), revoked at 13:40 with text "external EPFS lost"

ALR!*13:38 general failure 6

Alarm, new and valid with ID Number 6, not yet revoked at 13:38 with text "general failure".

ALR! 13:39 no sensor pos in use26

Alarm, old, still valid and requiring attention, with ID Number 2, arrived at 13:39 with text "no sensor position in use"

13:43 11/21 ----- POS:01/05

AddressedSRM 5264

Text:PIRATE ATTACK!

The text of the selected message (in this case Message POS 01/05) is shown in the text field.

ASRM – Reading Incoming Addressed Safety Related Messages:

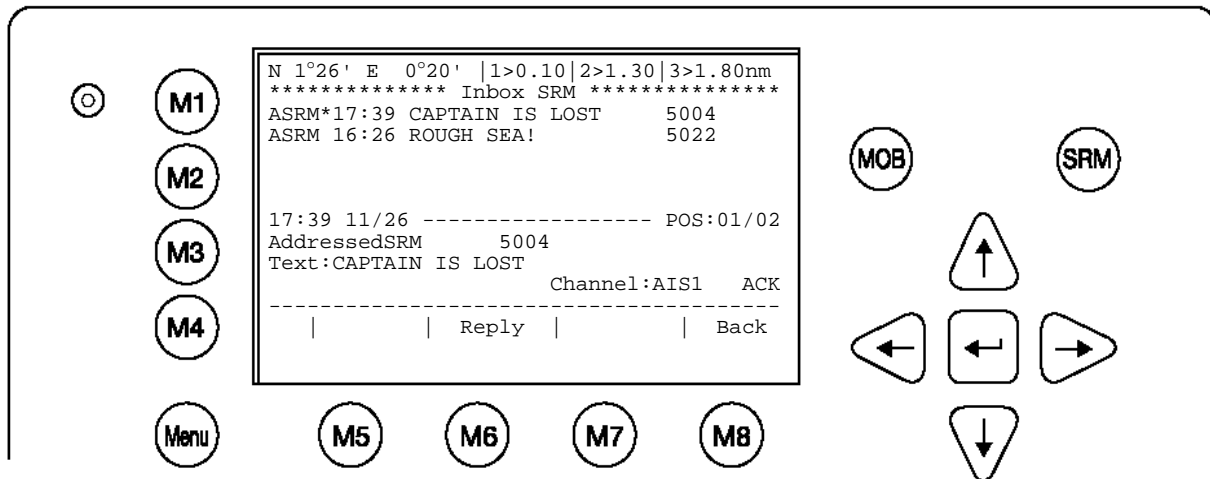

ASRM:	Information
Time	17:39
Date	11/26 (mm.dd)
POS	01/02 (Message 01 of 02)
Message Type	AddressedSRM
Status	* (not acknowledged)
MMSI of Sender	5004
Channel	Incoming AIS Channel
ACK	Message not yet acknowledged

ALR – Reading Incoming Alarms:

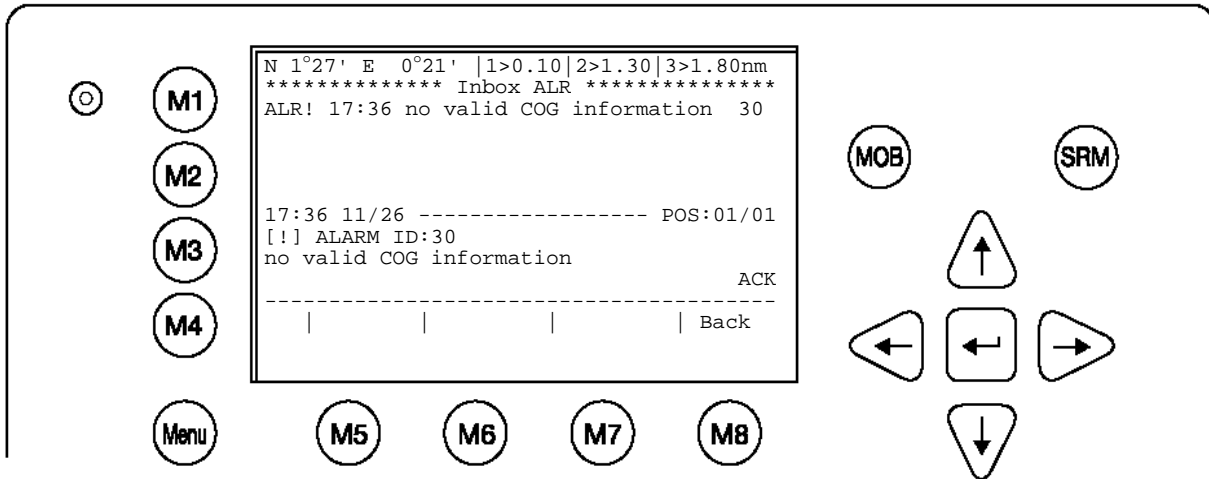

ALR:	Information
Time	17:36
Date	11/26 (mm.dd)
POS	01/1
Message Type	ALARM
Alarm ID	30
Status	[!] Valid alarm, requiring action

h) Writing a “Estimated Time of Arrival” (ETA) Message

Upon selection of “3. Lock Request” in the Message Menu, the Lock Request (ETA) Editor appears. The Message contains:

- The address of the recipient of this ETA – Message (the default is “2000000”). The address could be received from the authority.
- The RIS Identifier / location code of the Lock. This code is divided into 5 parts. It has to be keyed in with the UN - values of that particular destination.
- The number of tug boats that are required. Valid entries are 0-6 (7 = unknown = default).
- The estimated time of arrival in the format MMDDhhmm (month-day-hour-minute).

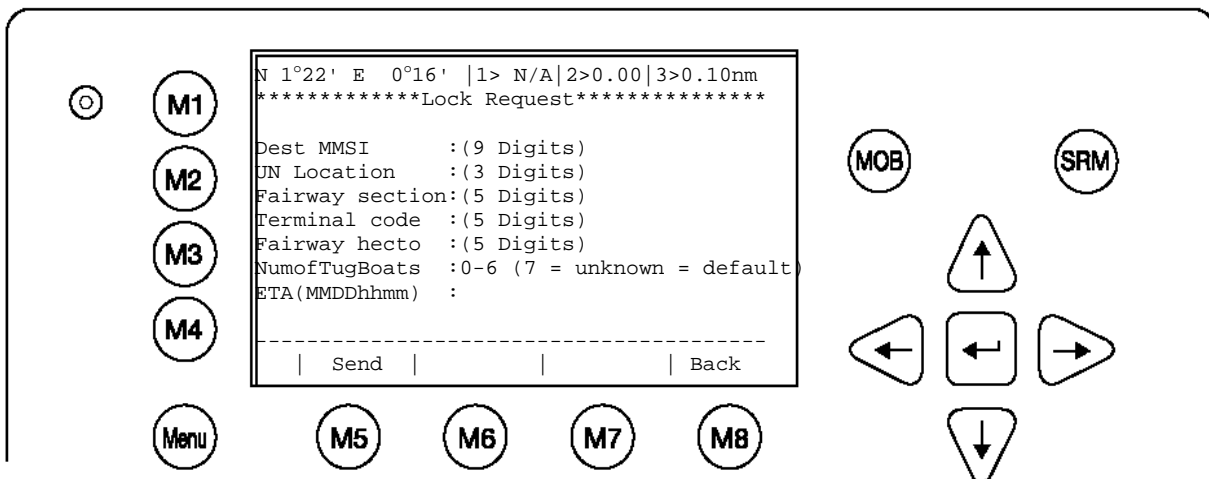

Dynamic Keys: Broadcast Message Editor				
[M5]	[Send]	Send Message	[Enter]	Send Message
[M8]	[Back]	Return to Messages Menu		

RIS IDENTIFIER/ LOCATION CODE

Data Elements

The full Location Code has the following elements:

- 1 UN Country code (2 digits)
- 2 UN Location code (3 digits)
- 3 Fairway section No. (5 digits)
- 4 Terminal code or passage point code (5 digits)
- 5 Fairway section hectometer (5 digits),
in the database treated as an attribute to the fairway section number.

The location must be given unique which can happen in different ways depending on the purpose of reporting and the local situation.

Example:

UN Country code	UN Location code	Fairway section	Terminal code	Fairway Hecto-metre
DE	TRI	03201	LOCK	00000

This is the RIS Identifier / location code of the Mosel - Lock in Trier / Germany.

i) Inbox of a received “Requested Time of Arrival” (RTA) Message

Upon selection of “7.Inbox Lock Reply” in the Message Menu, the received Reply to your ETA – Message appears. The Message contains:

- The timestamp of this message in the format MM/DD hh:mm.
- The location code of the Lock
- The requested time of arrival at the lock in the format MMDDhhmm (month-day-hour-minute).
- The status of the lock (operational / not operational).

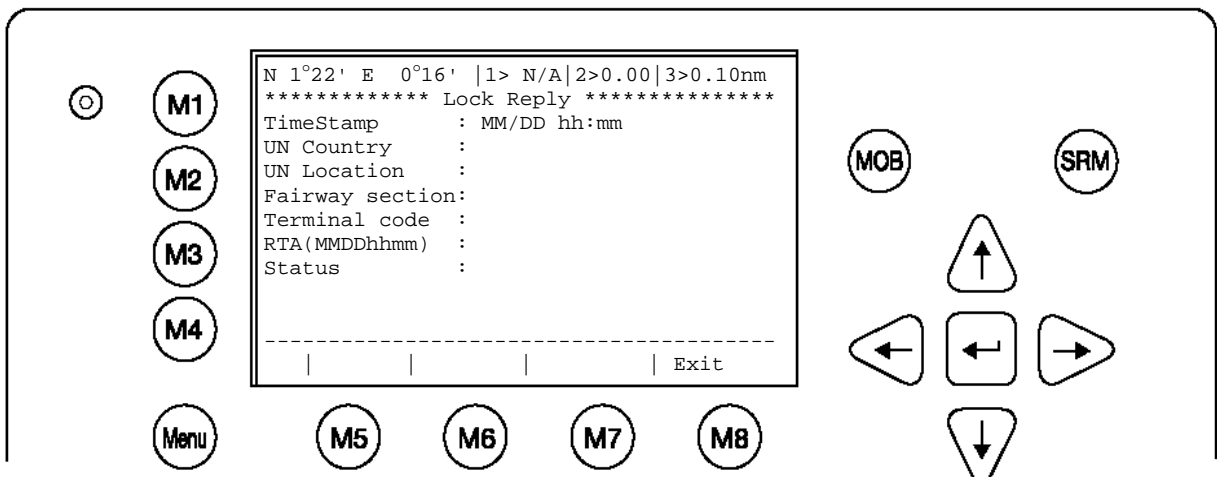

Dynamic Keys: Broadcast Message Editor				
[M8]	[Back]	Return to Messages Menu		

j) Water Level Message

This message is sent by base stations to give water level information to all vessels in a certain area. The AIS can show up to 120 message entries. Messages are sorted by country code and gauge ID, which is the unique identification of the measuring point. Information from same gauge will be overwritten by the latest message. Water levels older than 1 hour will be deleted automatically.

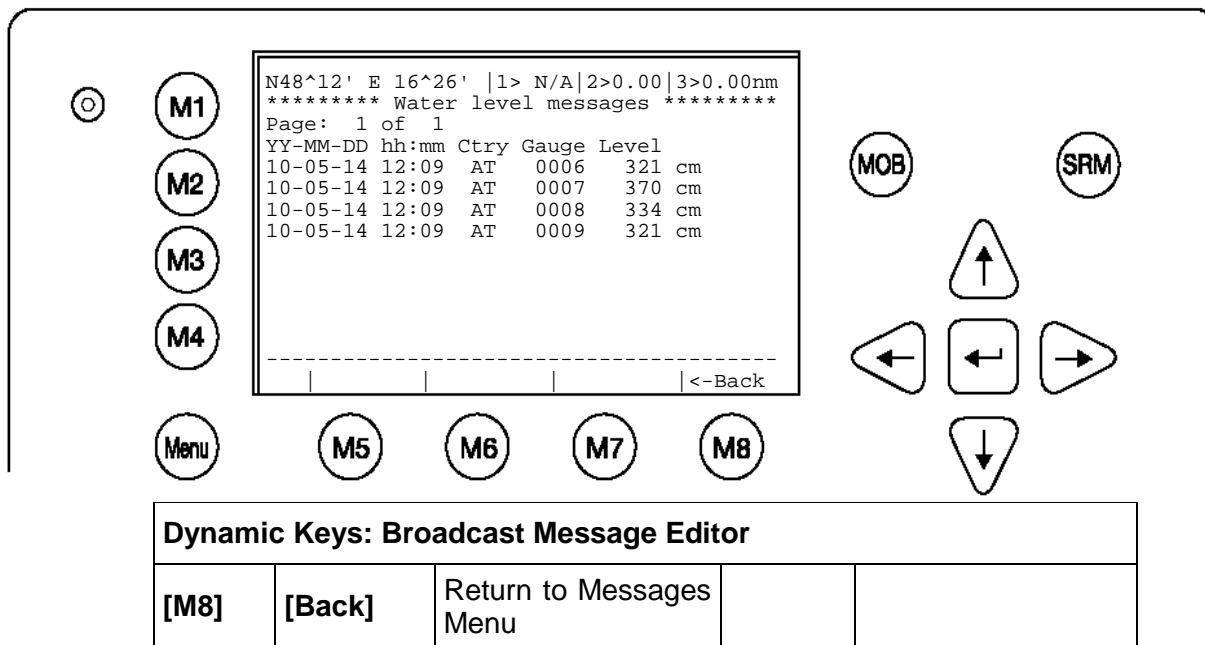

3.5.2 AIS Status

a) State / Conditions

This screen provides a means to viewing the current AIS status of all vessels within receiving range. The information reported is own vessel's last AIS contact with the other vessel in the listing (**Time**), the Transponder mode (**Mod.**), the synchronization status (**Syn.**) and the total number of vessels being received by each vessel in the listing (**RXVe**). The vessel's (**MMSI**) number is also shown on the right hand side of the screen.

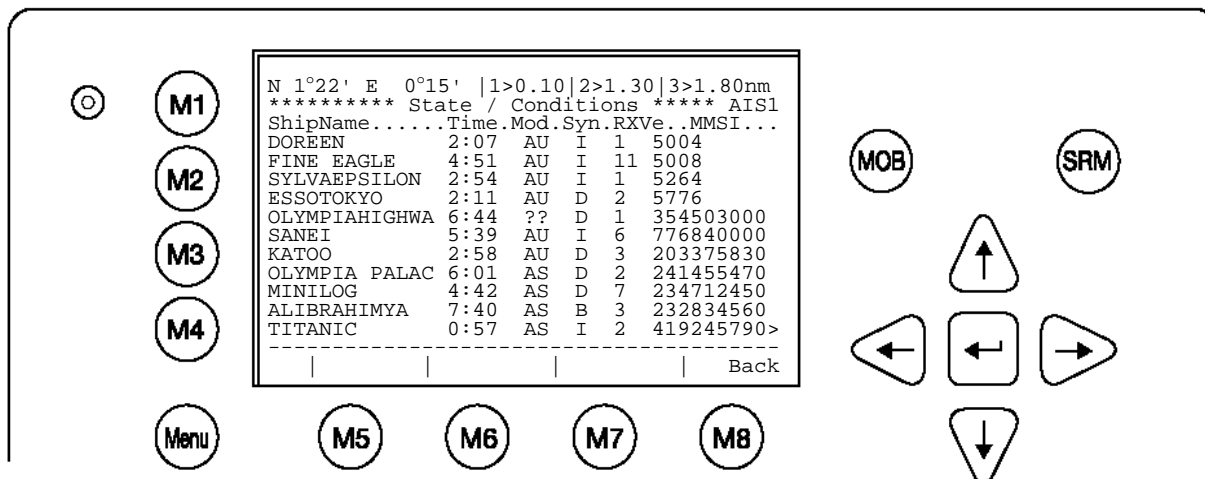

Mod.:	AIS Transmission Mode
AU	Autonomous
AS	Assigned
IN	Interrogation/Polled Mode
??	Unknown
Used Channel	AIS1, AIS2
Syn.:	(UTC source)
D	UTC direct
I	UTC indirect
B	Sync to Base
A	Sync to mobile with the most received stations (Semaphore)
RXVe:	Total number of all received stations by the individual vessel.
MMSI:	MMSI number of the individual vessel.

b) Own Ship Data

This screen shows own Ship, and Voyage Data, which was previously input in Menu 3: Ship Settings and Menu 4: Voyage Settings.

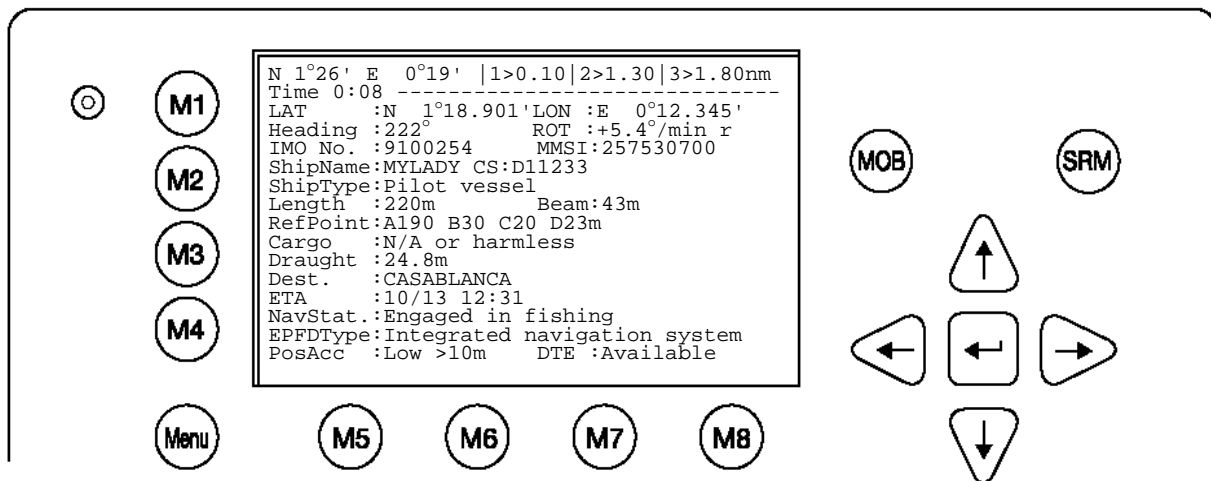

Own Vessel Position:

LAT : N 1°18.901' LON : E 0°12.345'

Heading and Rotation of own vessel:

Heading :77° ROT : +5.4°

IMO-Number and MMSI of own vessel:

IMO No. : 9100254 MMSI: 257530700

Name and CallSign of own vessel:

ShipName: MYLADY CS: D11233

Vessel Type:

Pilot vessel

Length and Beam of own vessel:

Length:310m Beam:73m

Reference Point (in meters):

This information indicates the Reference Point of the used GPS Antenna onboard the vessel.

RefPoint: A190 B120 C10 D>63m

A: 190m
 B: 120m
 C: 10m
 D: >16m

Vessels Cargo:

Indicates the type of cargo on board

N/A or harmless

Further Vessel Details:

Draught : 3.3m
Dest : HAWAII
ETA : 10/15 12:31
NavSt : Moored

Information on the vessel's Equipment Position Finding Device:

EPFDType: GPS

Position Accuracy and Data Terminal Equipment (DTE):

PosAcc :High <10m DTE :Available

The accuracy of the position is higher than 10 m (= High <10m), the opposite would be less than 10m (= Low >10m). This information indicates that the vessels Transponder is connected with a user interface and can show AIS Data. This function basically ensures that the current Transponder being used is fitted with a display and can therefore send and receive messages. As the NAUTICAST™ is fitted with an integrated display unit, it will always show "DTE: Available".

Additional Inland Vessel details:

European Vessel Identification Number (ENI):

ENI : 0IR44070

Blue Sign: N/A means ship does not have a Blue Sign (see chapter: 3.5.5 0)

Blue Sign: N/A

Additional Inland Vessel dimension and information:

Length: 27.5m	Beam: 5.5m
Drauth: 7.1m	
Convoy: 8444 - Pass.ship no accomodat	
Load: unloand	Hazardas: N/A
Quality: Speed: Lo	Course: Lo Heading: Lo
Persons on Board:	
Crew: 2	Support: 1
Int'l: 4	Passengers: 1

c) Version Info

This Screen shows the actual Software Release which is being run on the NAUTICAST.

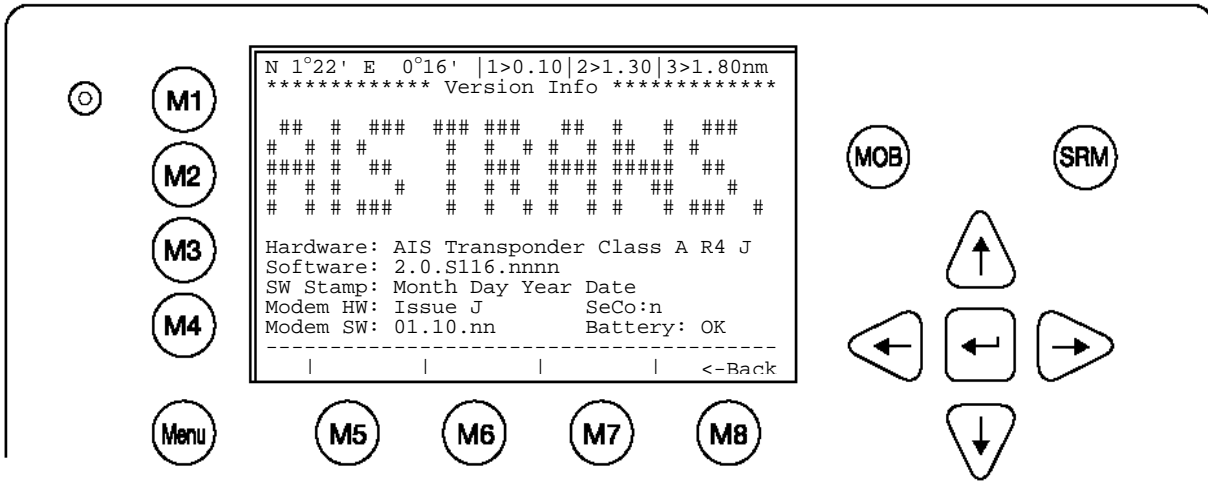

d) Security Log

The Security Log is implemented to show the “switched off” – times of the transponder. In standard operation, this Log should not contain any entries.

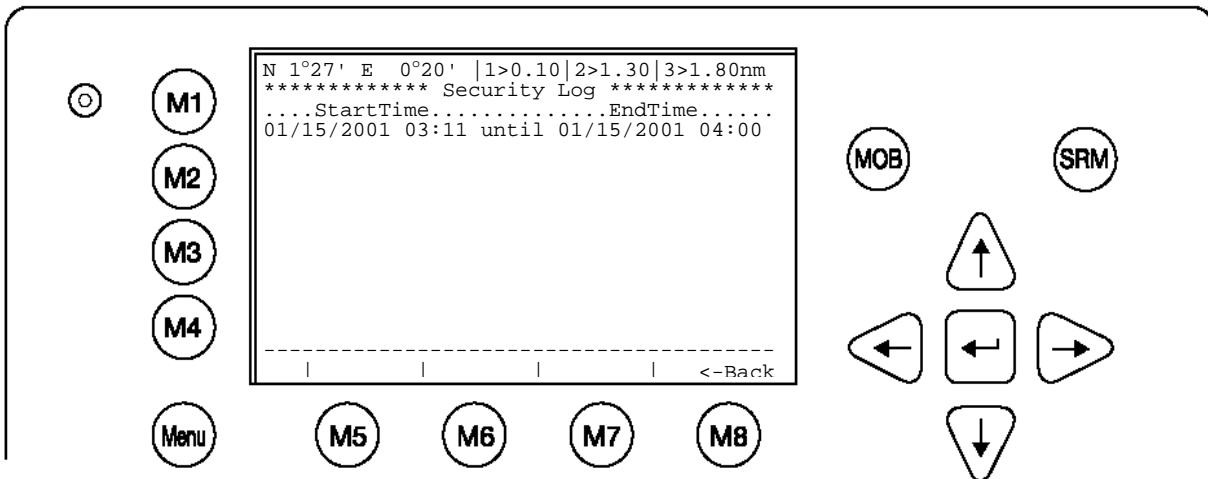

3.5.3 Voyage Settings (User Password Protected)

Select the “Voyage Settings” – Sub Menu from the Main Menu with the cursor button [Up] & [Down] or press No. 3 on the keyboard

NOTE: The default password from the factory is mentioned on your AIS display at the protection foil. (see Appendix 7.3 for password information).

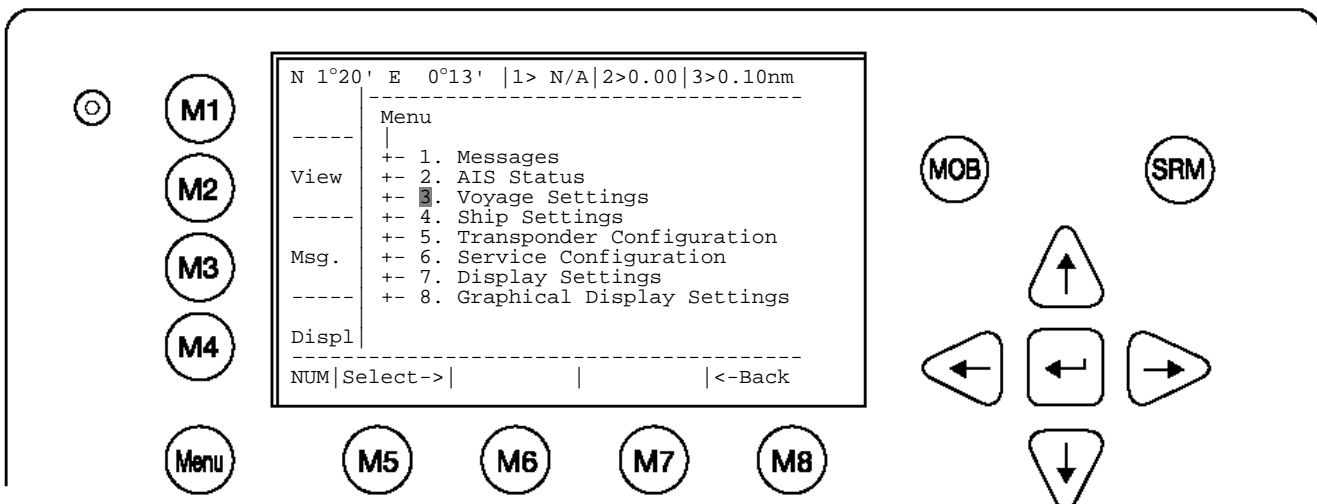

The password query field appears. Input new User Password and press [Enter].

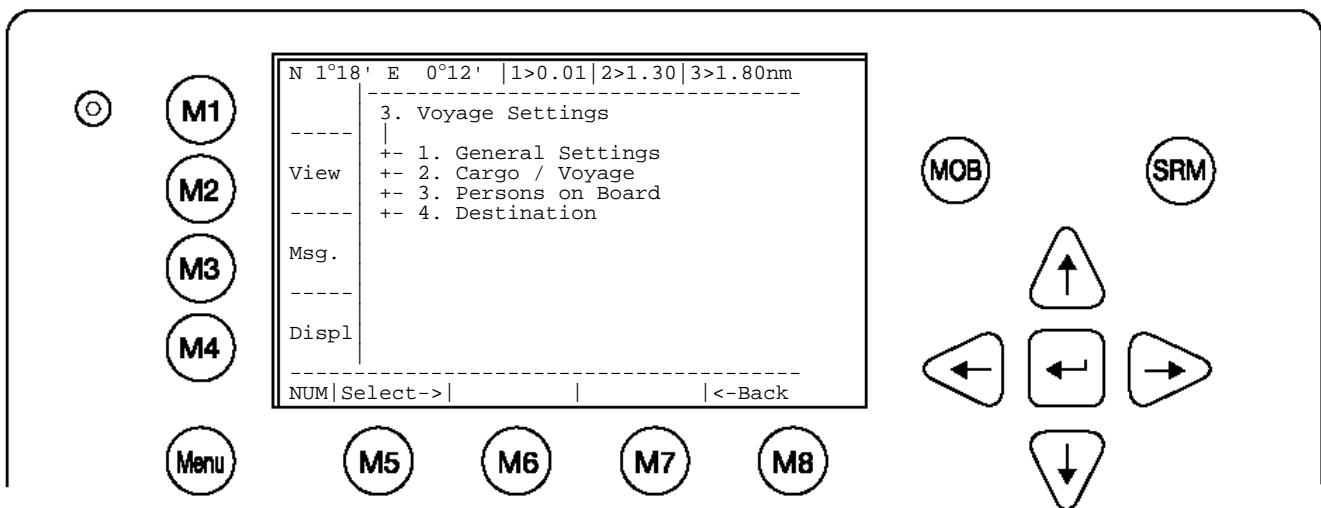
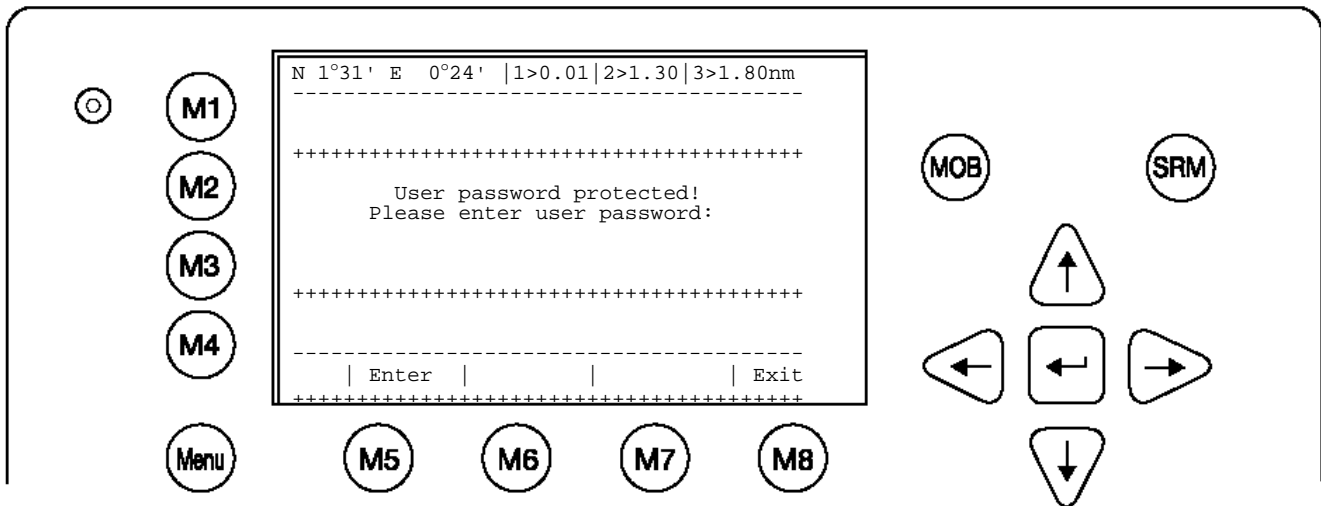

Select Submenu 1 “**General Settings**” with cursor button [Up] & [Down] by pressing No. 1 on the keyboard.

Scroll the Data Fields with [Enter] and input own vessel data. Enter a draught in meter and air-draught value in centimetre (cm = m/100) as well as the correct navigational status setting.

Save the new settings by pressing [Save], and return to the Main Menu Screen by pressing [Exit]. Press [Back] to return to the Main Menu without saving any changes.

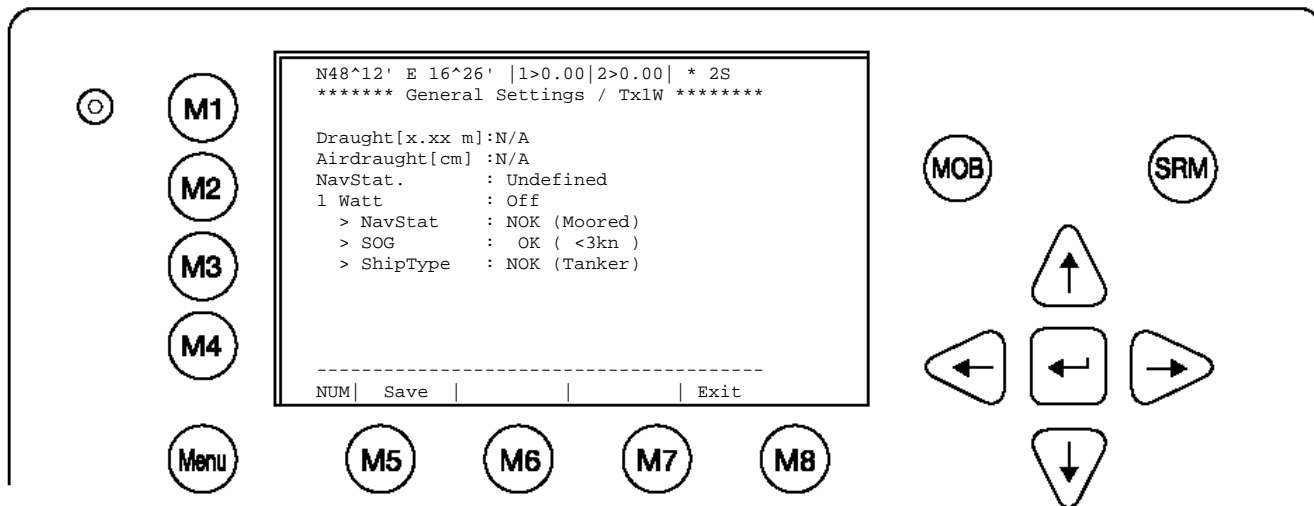

NavStat	Navigational Status	<ul style="list-style-type: none"> Under way using engine At anchor Not under command Restricted maneuverability Constrained by her draught Moored Aground Engaged in fishing Under way sailing Undefined
---------	---------------------	---

Select Submenu 2 “**Cargo/Voyage Settings**” with cursor button [Up] & [Down] or by pressing No. 2 on the keyboard.

Toggle the values for the **ERI ship type** (see Appendix 7.2), the hazardous cargo by the number of **Blue Cones** [0-3, B-Flag, Default/Unknown], and the loaded / unloaded status **Un/Loaded** [Loaded, Unloaded].

Save the new settings by pressing [Save], and return to the Main Menu Screen by pressing [Exit]. The ERI ship types, which are used in Inland message 10, are automatically converted to the IMO types which are used in IMO message 5 (refer to Appendix 7.2). Press [Back] to return to the Main Menu without saving any changes.

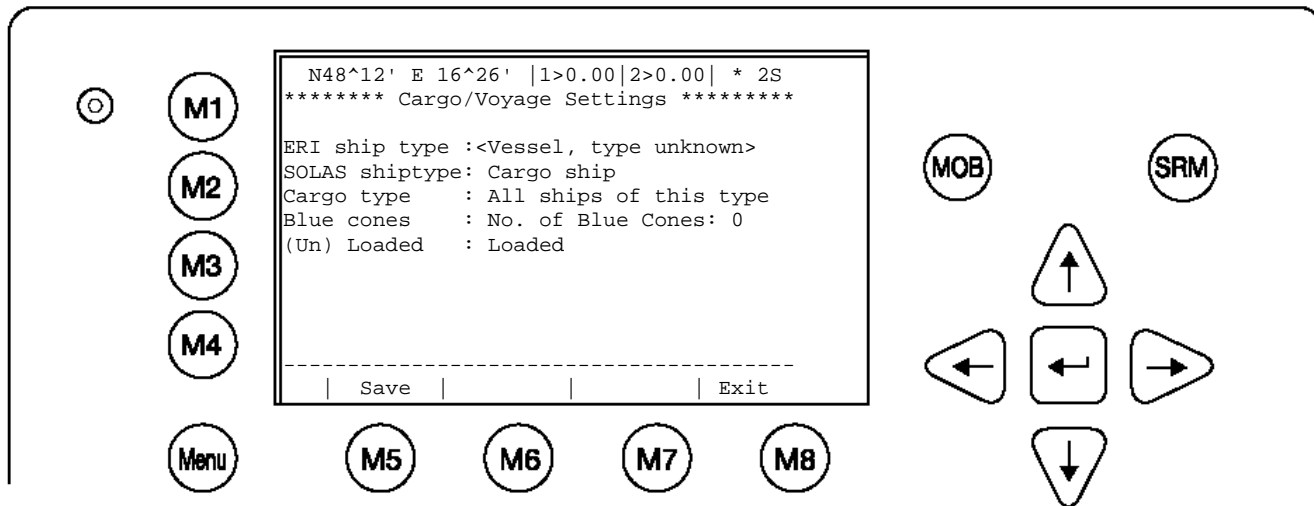

Select Submenu 3 “**Persons on Board**” with cursor button [Up] & [Down] or by pressing No. 2 on the keyboard.

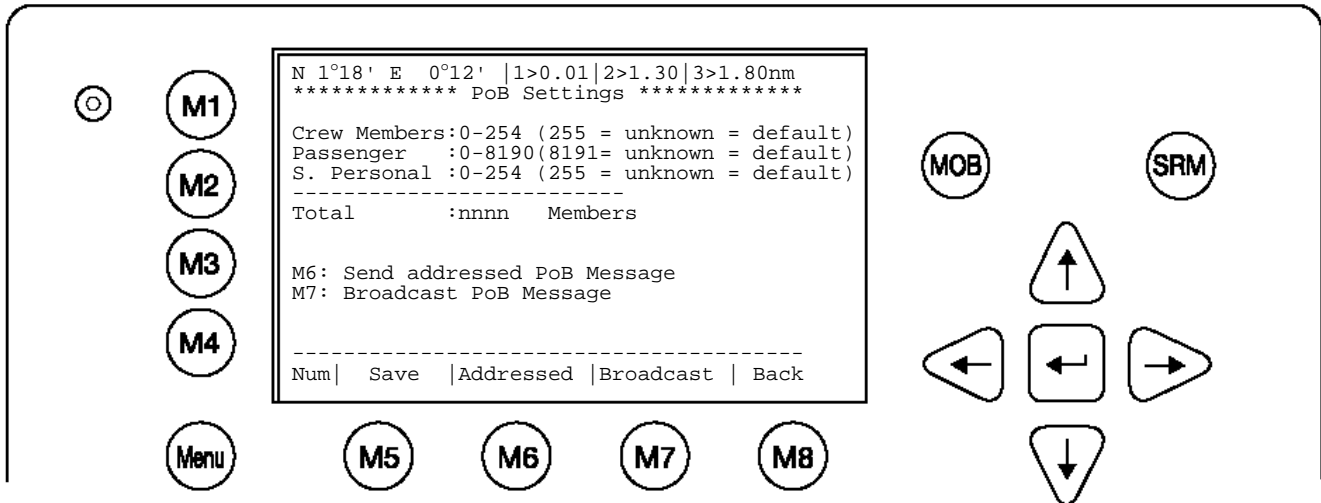

NOTE: The total number of persons on board will be calculated automatically. In “High Seas” mode this sum will be used for the AIS messages.

The “Persons on Board” could be transmitted via addressed or broadcast message. The following screen appears after the selection “Broadcast PoB message” by pressing M7.

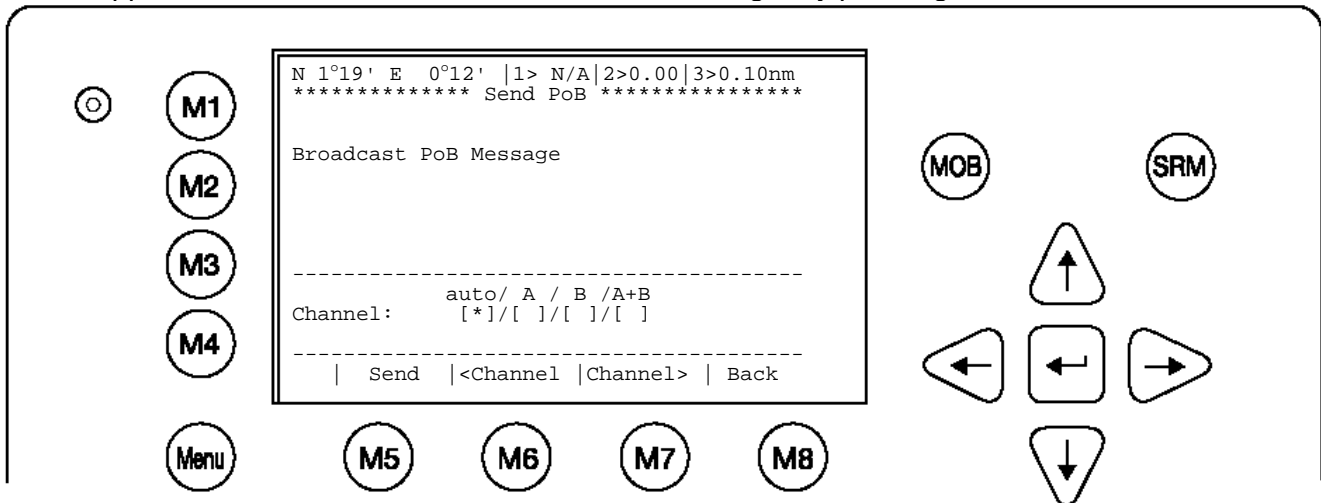

Dynamic Keys: Broadcast Message Editor				
[M5]	[Send]	Send Message	[Enter]	Send Message
[M6] [M7]	/ [Channel]	Select Transmission Channel (A+B is default)		
[M8]	[Back]	Return to Messages Menu		

NOTE: The addressed message operates equal to the addressed message (chapter 3.4) described in section “Writing Messages”.

Select Submenu 4 “**Destination**” with cursor button [Up] & [Down] by pressing No. 4 on the keyboard.

Select between ‘use mask’ and ‘input string’.

Input String: Direct input of the destination string. ETA(estimated time of arrival) has to be entered separately

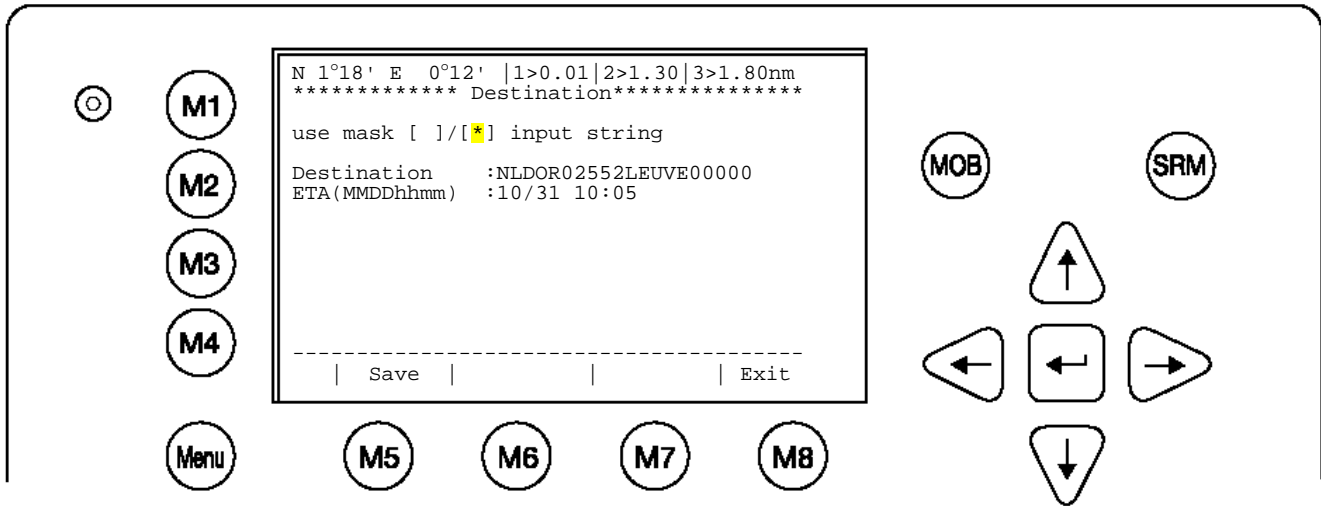

Mask input:

Scroll the Data Fields with [Enter] and input the UN destination codes as well as the ETA (estimated time of arrival) data.

Save the new settings by pressing [Save], and return to the Main Menu Screen by pressing [Exit]. Press [Exit] to return to the Main Menu without saving any changes.

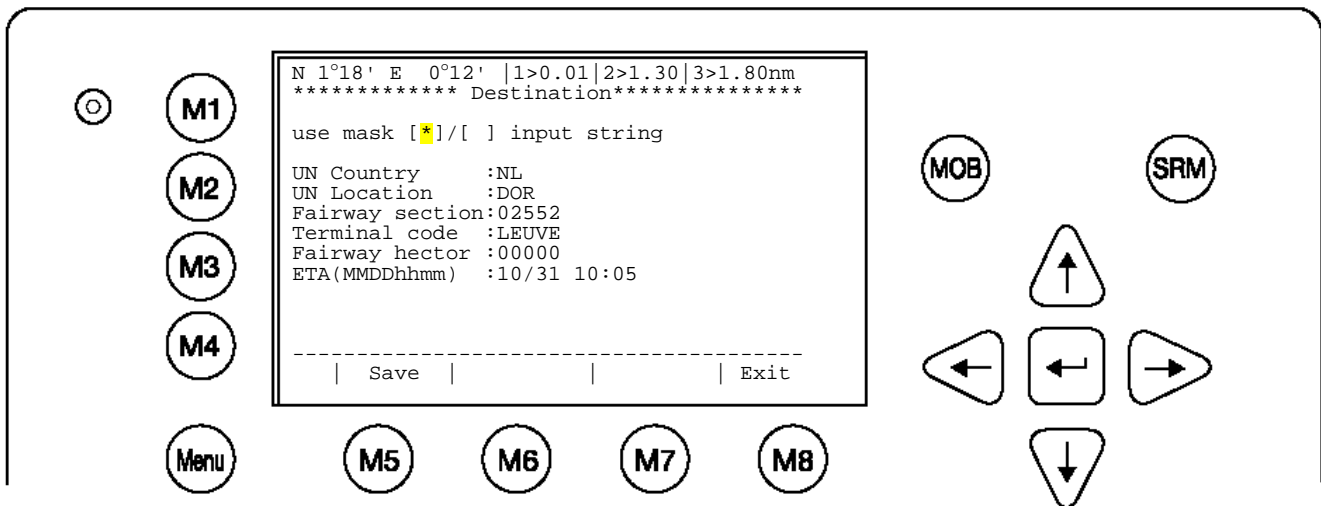

Toggle back to 'input string' converts your data to one string

Dynamic Keys: Input of Voyage Related Data					
[M5]	[Save]	Confirm Data Input	[M8]	[Exit]	Return to Main Menu

After the Voyage Settings have been input and saved, this screen appears. [Exit] takes the user back to the Main Menu.

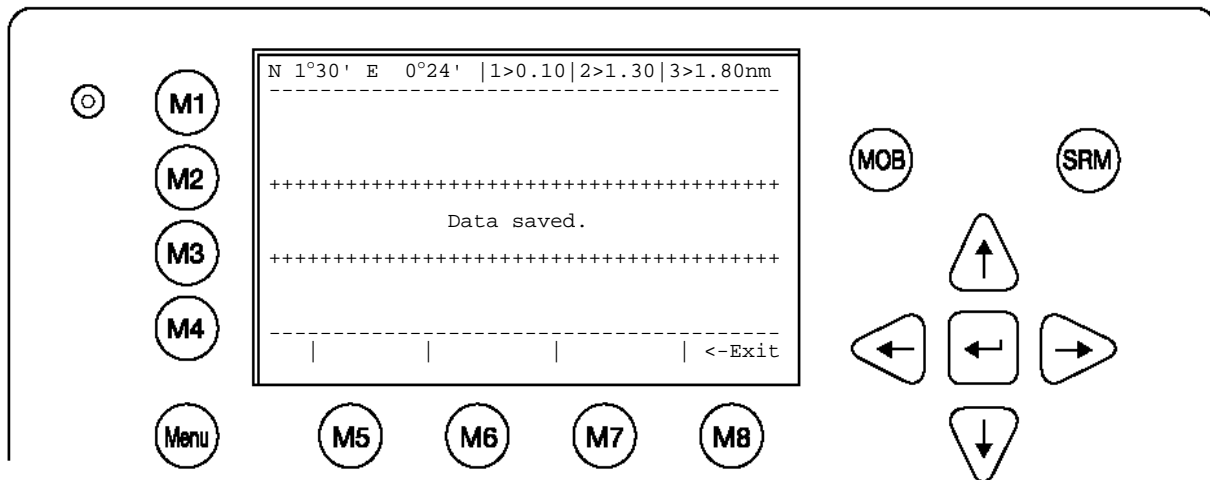

3.5.4 Ship Settings (User Password Protected)

Select "Ship Settings" with cursor button [Up] & [Down] or press No. 4 on the keyboard.

NOTE: Please see Appendix 7.3 for password information

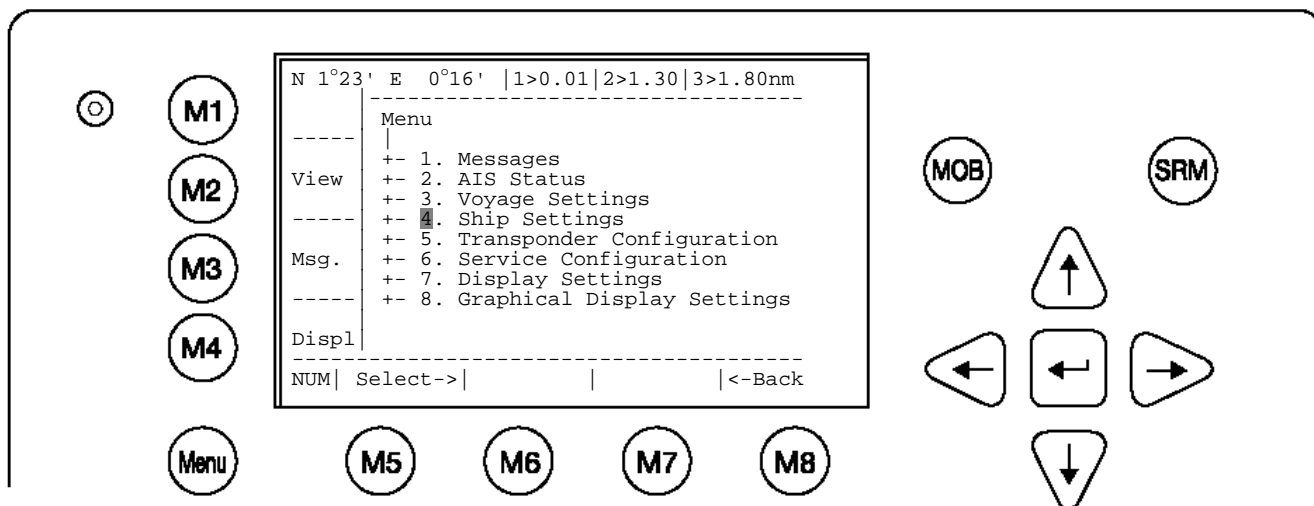

Input your User Password and press [Enter].

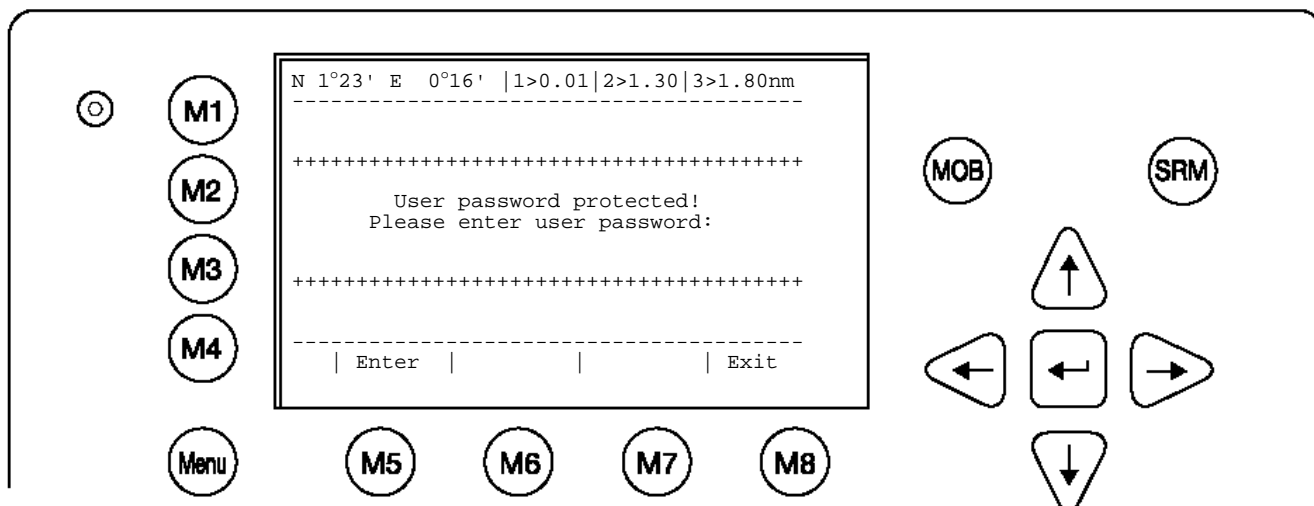

Scroll the Ship Settings Fields with [Enter] and input own convoy and vessel data.

Enter Call Sign: E.g: OEZ1234
 Enter Ship Name: E.g MV INLAND SHIP

NOTE: The reference point is defined by the 4 lengths A, B, C and D.

- A = the distance from bow to the antenna
- B = the distance from the antenna to the stern
- C = the distance from the port side to the antenna
- D = the distance from the antenna to the starboard side

The following example should illustrate how the fields Len and Beam (always the complete convoy) and the correct reference point should be used.

Example:

Length of ship (means the complete convoy) = 400m
 Beam of ship (means the complete convoy)= 32m
 Internal GPS-Antenna is mounted 20 meters from stern and 24 meters from starboard.

Length[dm] : 3999dm (approximated to Len (A+B))
 Beam[dm] : 319dm (approximated to Beam(C+D))
 RefPtExt: A: 380m
 B: 20m
 C: 12m
 D: 20m

(must be the same as internal Reference point when no external GPS is connected)

RefPtInt: A: 380m
 B: 20m
 C: 12m
 D: 20m

The full line as shown will be displayed after pressing Enter:

Ship length and beam have to be entered in dm. Conversion 1m is 10dm.

NOTE: The field Len[dm] and Beam[dm] are necessary for the lock. The values of Len (A+B) and Beam (C+D) has to be the rounded up value from Len[dm] and Beam[dm] e.g.: 3999dm is 400m.

Save the new settings by pressing [Save]. Press [Back] return to the Main Menu Screen without saving any changes.

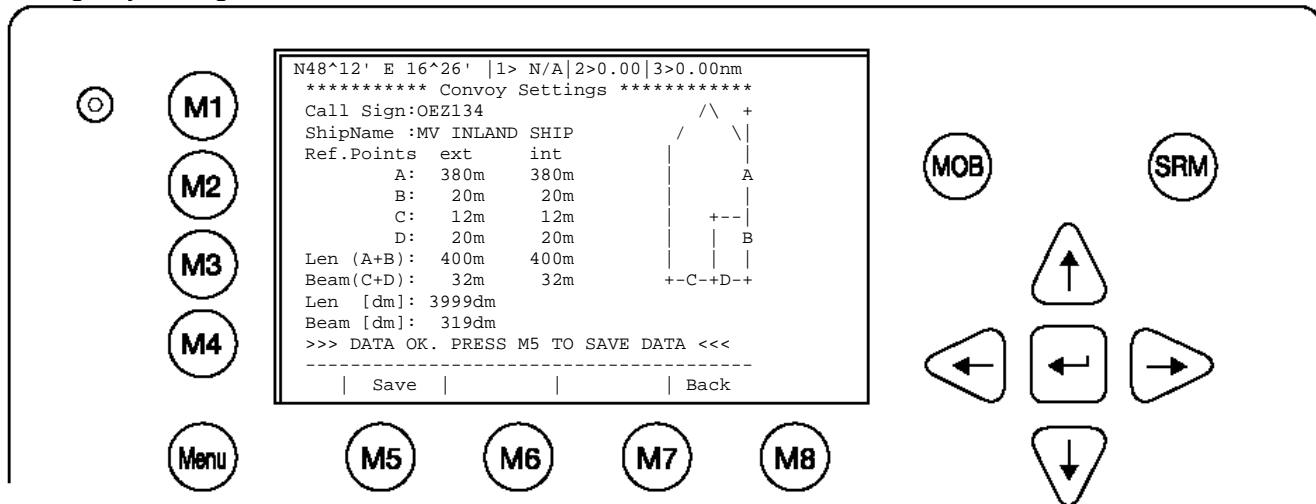

Dynamic Keys: Input of Ship Settings					
[M5]	[Save]	Confirm Data Input	[M8]	[Back]	Return to Main Menu

After the Ship Settings have been input and saved, this screen appears.
[Exit] takes the user back to the Main Menu.

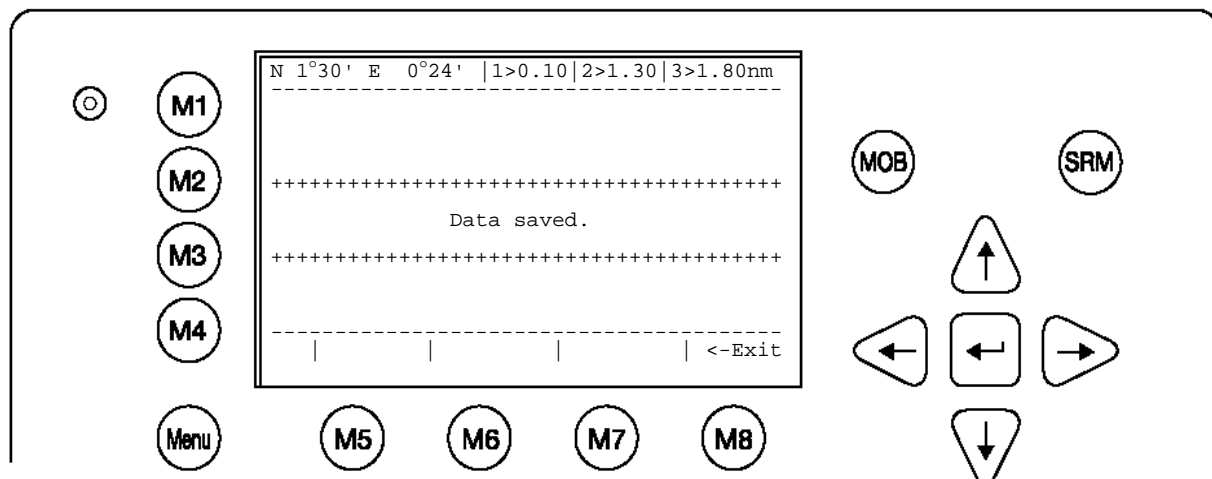

GPS Antenna Mounting

It is important to input the exact mounting position of the GPS Antenna on the vessel as this influences the accuracy of the displayed target in an ECDIS.

(RefPntExt:) = The position of any external positioning device (GPS Antenna) used as primary position source.

(RefPntInt:) = The position of the GPS Antenna (fallback device in case primary source is disabled).

NOTE: When receiving position data from large vessels, it should be considered that the position refers to the antenna mounting point upon the vessel. To ensure accurate navigation, the antenna reference points (see Other Vessels Details) should be taken into consideration when determining the vessels position.

Also, the electronic chart display in use should be programmed to consider the antenna reference points. Traffic images are represented in true distances only when all displayed targets, including own vessel, are working with AIS position information, which considers antenna reference points.

3.5.5 Transponder Configuration (User Password Protected)

The Configuration Menu allows the user to alter the hardware-based parameters. User Password Configuration is also undertaken here.

Accessing the Configuration Settings:

The Configuration Menu is User Password protected.

NOTE: Please see Appendix 7.3 for password information.

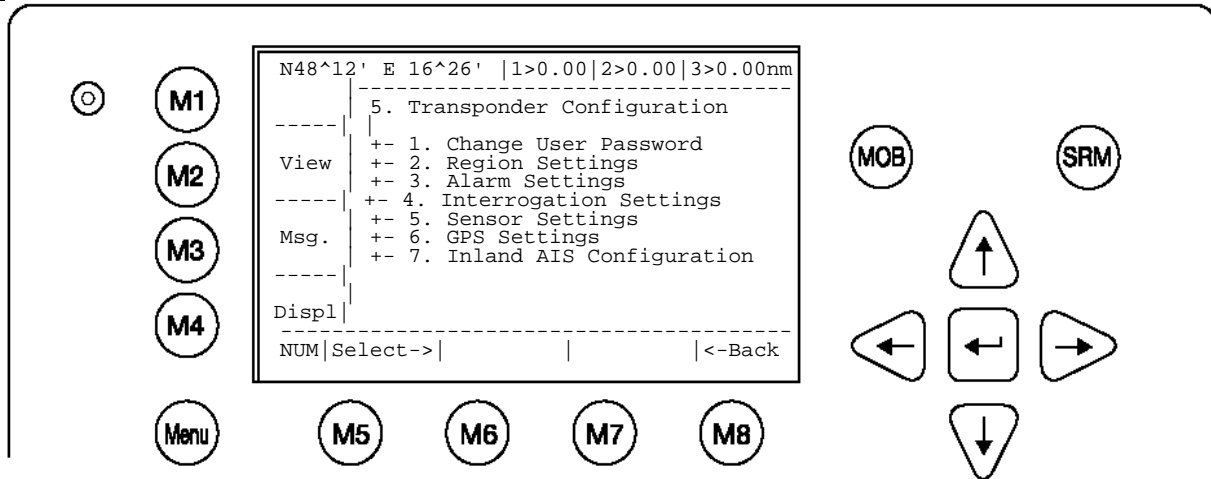

Dynamic Keys: Transponder Configuration

[M5]	[Select]	Select desired Submenu	[M8]	[Back]	Return to Main Menu
------	----------	------------------------	------	--------	---------------------

Accessing the Configuration Menu (Please see Appendix 7.3 for password information)
The letters of the Password appear as * when being input on the screen.

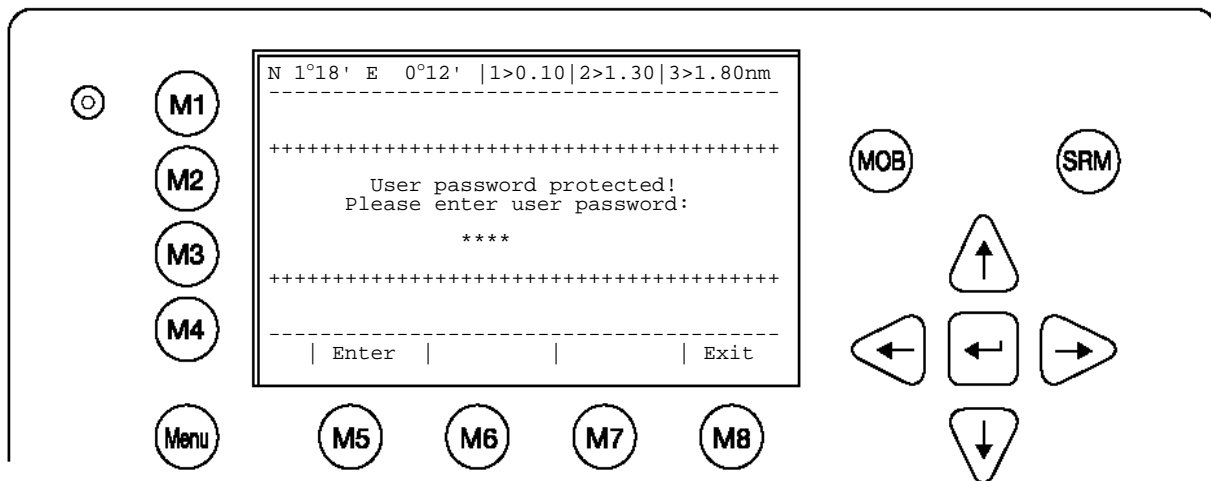

Dynamic Keys: Input of Default User Password to Access Configuration

[M5]	[Enter]	Confirm Default User Password Input	[M8]	[Exit]	Return to Vessel Listing
------	---------	-------------------------------------	------	--------	--------------------------

Incorrect User Password Input

If the incorrect User Password is input, the screen below appears.

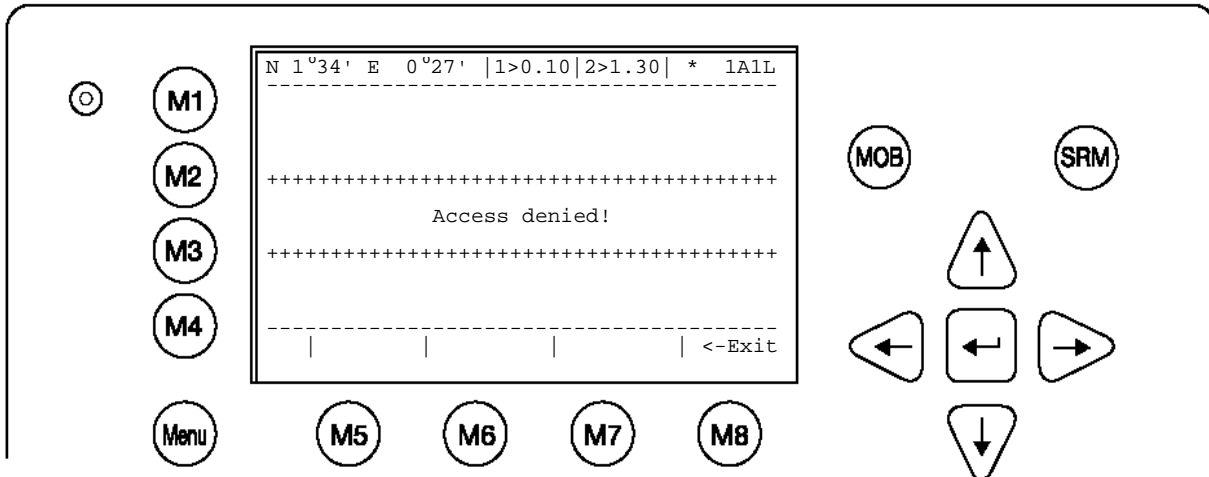

Dynamic Keys: User Password Input (Access Denied)

[M5]	[Exit]	Return to Vessel Listing
------	--------	--------------------------

a) Change User Password (for initial NAUTICAST™ Operation)

It is strongly recommended to change the default User Password upon initial NAUTICAST™ operation.

The new User Password can be between 6 - 8 characters in length, and is not case sensitive.

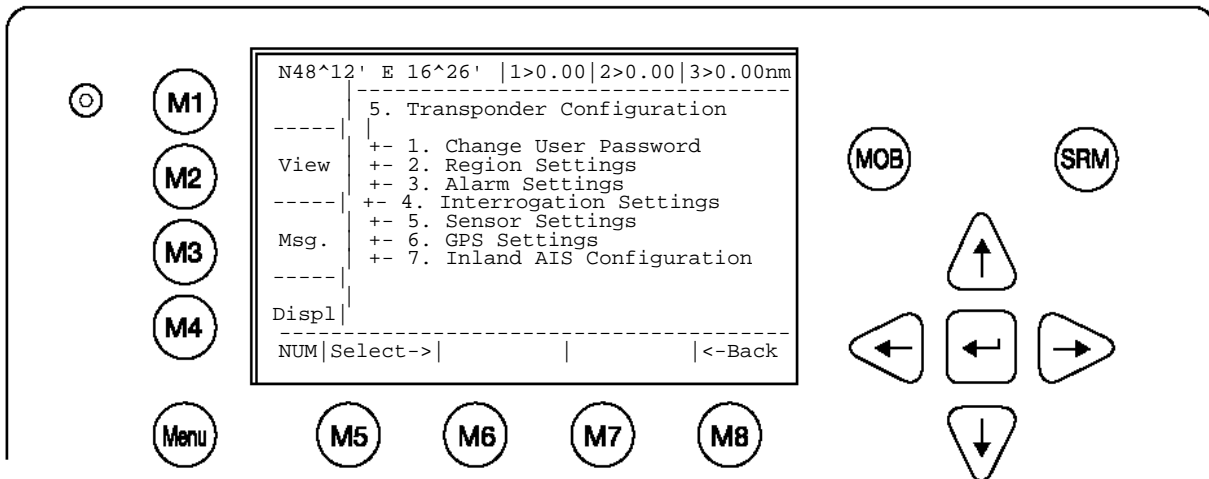

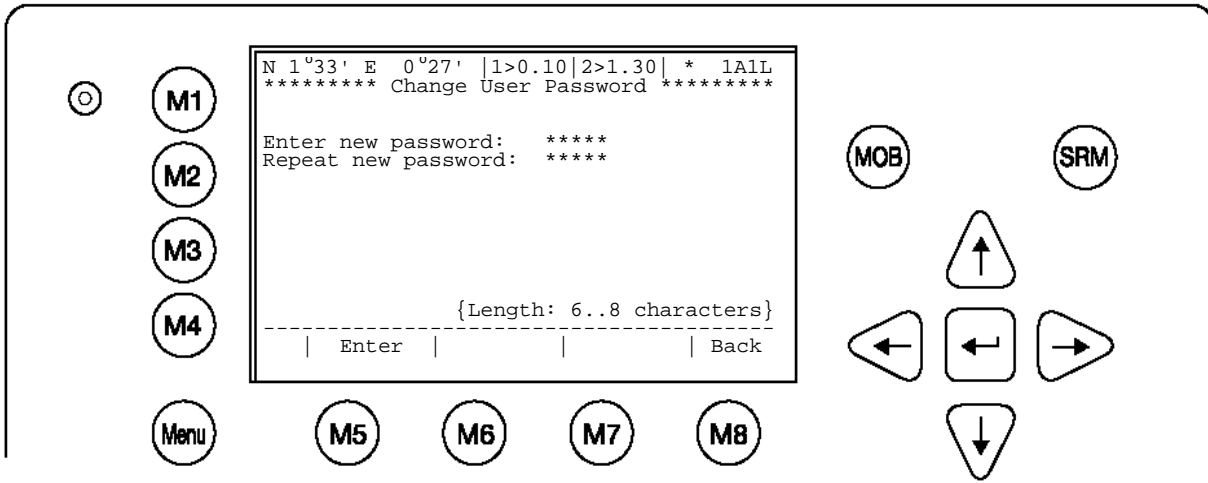

Dynamic Keys: Initial User Password Setting					
[M5]	[Enter]	Confirm User Password Input	[M8]	[Back]	Return to Menu Configuration

This screen appears if the new User Passwords are mismatched - i.e. the New User Password and the Repeated New User Password are not identical.

In this case, it is possible to re-input both the New and Repeated User Passwords again. [Exit] takes the user back to the User Password Input Screen.

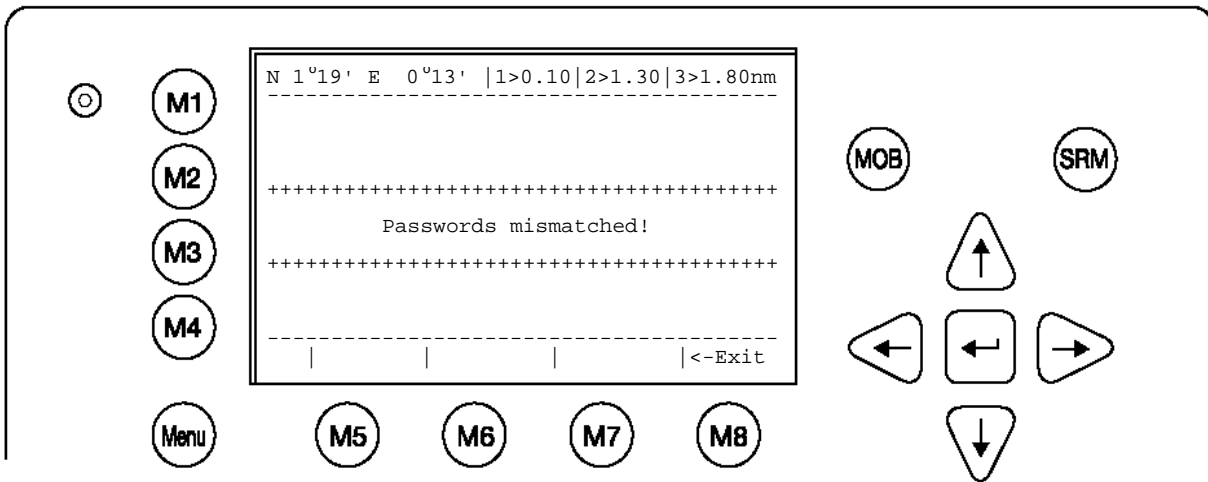

Dynamic Keys: User Password Input (Password Mismatched)		
[M5]	[Exit]	Return to Password Input Screen

The new User Password configuration has been saved.

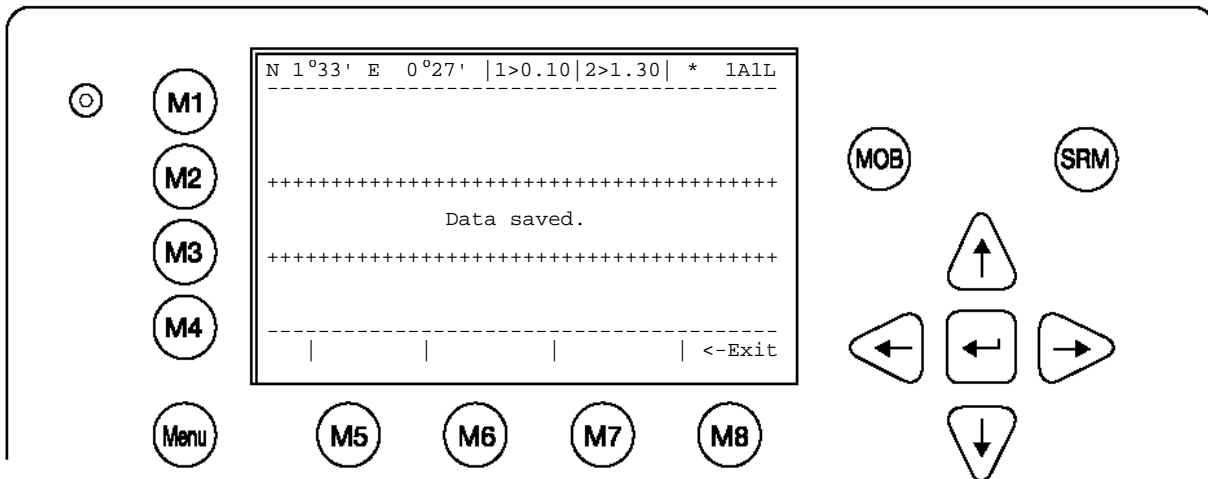

b) Region Settings

A Region is a defined area, with specific VHF parameters, which are sent out by Vessel Traffic Service Stations (VTS), and received via Digital Selective Calling (DSC) or AIS.

The screen shows a list of Regions, and their input sources. When the vessel enters into one of the pre-defined Regions, the NAUTICAST™ automatically switches to the relevant Region Setting. If a Region Number is vacant, then the relevant Region Name Slot is currently unoccupied.

Tip: For fast Region Selection, press the Region Number on the keyboard and the selected region is immediately displayed.

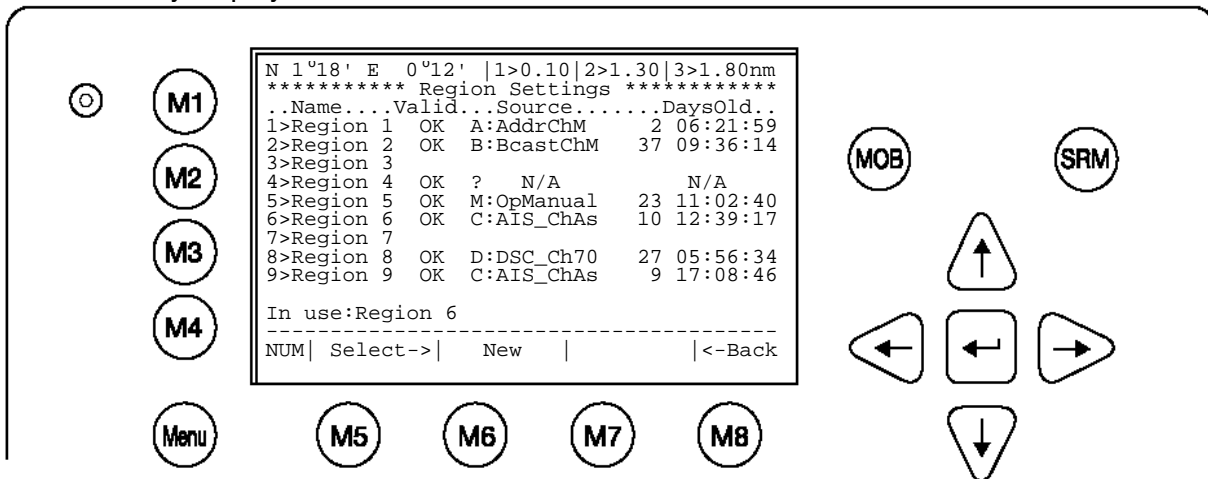

Dynamic Keys: Region Settings				
[M5]	[Select]	Confirm Region Number Selection	[Back]	Return to Menu Configuration
[M6]	[New]	Create New Region		

Overview of Region Settings

Name	Region Number	Number of pre-defined Region
Valid	OK	Status of Region Setting - OK: Stored and Valid
Source	A:AddrChM	A: Addressed Channel Management (Msge. 22) Source: VTS via AIS
	B:BcastChM	B: Broadcast Channel Management (Msge. 22) Source: VTS via AIS
	C:AIS_ChAs	C: AIS Channel Assignment Sentence Source: Manual ECDIS Input
	D:DSC_Ch70	D: Channel 70 Telecommand Source: Digital Selective Calling
	M:OpManual	M: Operator Manual Input Source: Via Display
DaysOld	Period of time Region Setting is stored	Days, hours, minutes, seconds (dd hh:mm:ss)
In use	Region 6	Region Setting of vessel current operation

Creating a New Region

Parameters for setting up a new Region can be entered and saved here.

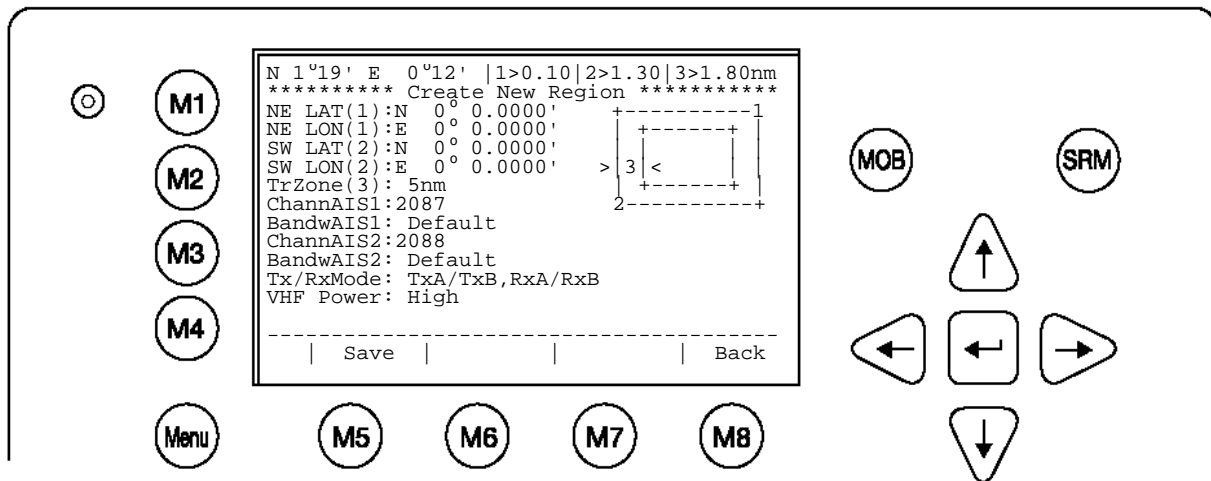

Dynamic Keys: Initial User Password Setting

[M5]	[Save]	Confirm Region Data Input	[M8]	[Back]	Return to Region Listing
------	--------	---------------------------	------	--------	--------------------------

Inputting Region Settings: Mode of Latitude and Longitude Input:

Example: 44 Degrees, 13.1234 minutes, North

Input Format: N 44-13.1234

Input Modes for New Regions			
Data Field	Field Description	Input Modus	Additional Information
NE LAT(1)	Latitude N/E corner	Manual Input	Degrees and minutes
NE LON(1)	Longitude of N/E corner	Manual Input	Degrees and minutes
SW LAT(2)	Latitude of S/W corner	Manual Input	Degrees and minutes
SW LON(2)	Longitude of S/W corner	Manual Input	Degrees and minutes
TrZone(3)	Transitional Zone Size	<Selection>	Nautical Miles
ChannAIS1	Primary AIS Channel	Manual Input	Channel Number
BandwAIS1	Bandwidth for Primary AIS Channel	<Selection>	Default Setting as defined by the channel number
ChannAIS2	Secondary AIS Channel	Manual Input	Channel Number
BandwAIS2	Bandwidth for Secondary AIS Channel	<Selection>	Default Setting as defined by the channel number
Tx/RxMode	Channel Modes	<Selection>	Tx : Transmitting Mode Rx: Receiving Mode
VHF Power	VHF Power Settings	<Selection>	Low = 2 Watt (Default for Ports) High = 12,5 Watt (Default for High Sea Regions)

c) Alarm Settings

This screen allows the user to enable or disable the generation and display of Alarms. Alarms are displayed in the Alarm Inbox (see Menu 5: Transponder Configuration, Submenu 3: Alarm Settings) and on the ECDIS screen.

NOTE: It is highly recommended to enable the alarm function.

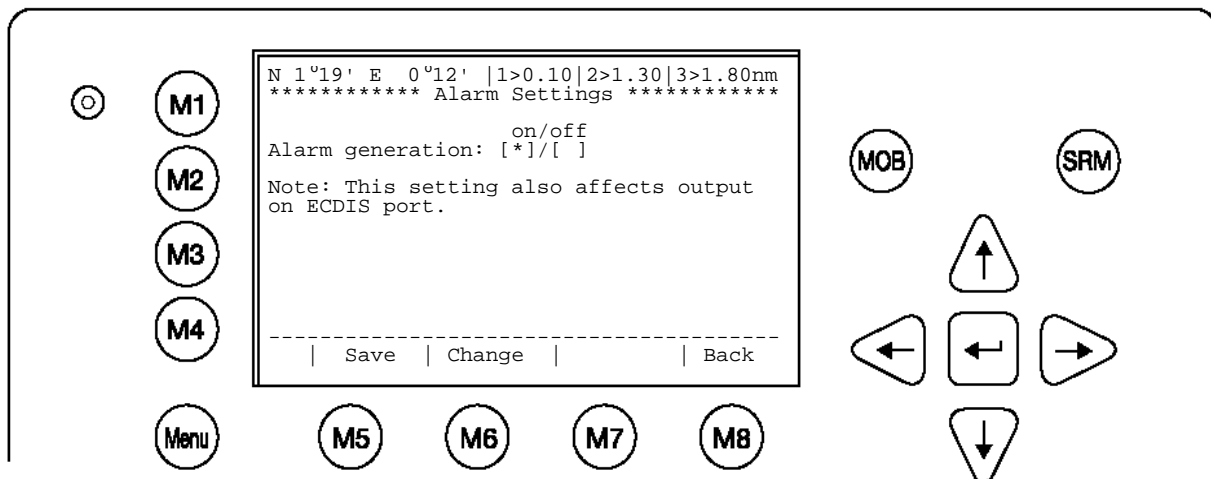

Dynamic Keys: Alarm Settings				
[M5]	[Save]	Save Alarm Settings	[Back]	Return to Submenu Configuration
[M6]	[Change]	Configure Alarm Generation (on/off)		

A detailed listing of the possible alarms can be found in paragraph 5.2.

d) Interrogation Settings

This screen allows settings for modes of response to Long Range Interrogation Requests (LRI). It is possible to set the AIS station to respond automatically or manually to LR Interrogations, and determine which vessel data may be interrogated. It is further possible to reply to incoming LRI's.

Long Range Interrogation Settings:

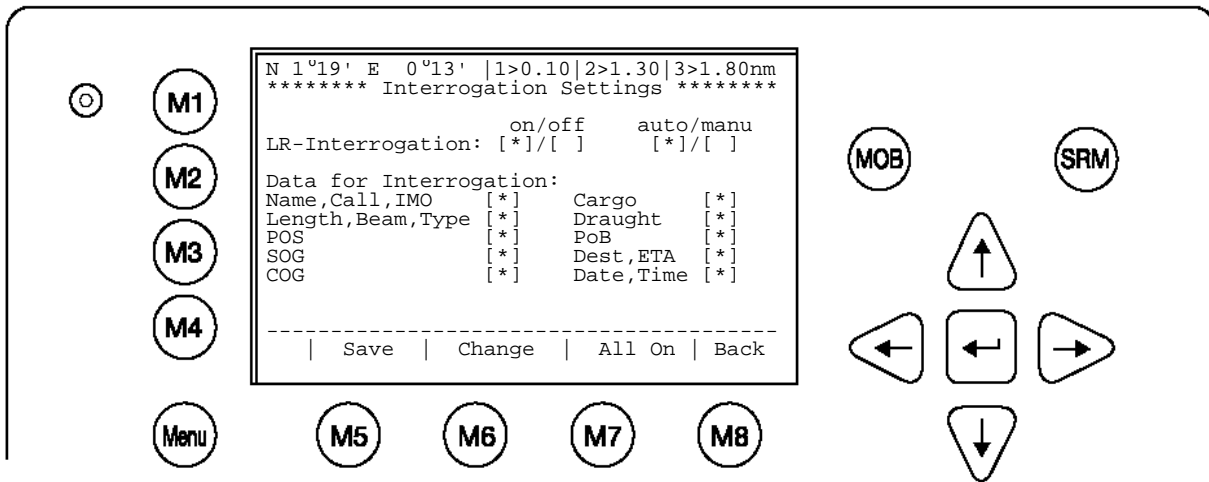

Dynamic Keys: LR Interrogation Settings				
[M5]	[Save]	Save LRI Settings	[Up] [Down]	/ Select Data Field for Configuration
[M6]	[Change]	Enable or Disable selected Field for Interrogation	[Enter]	Select Data Field for Configuration
[M7]	[All On]	Configure All Data for Interrogation	[Left] [Right]	/ Enable or Disable selected Field for Interrogation
[M8]	[Back]	Return to Menu Configuration		

Replying to a Long Range Interrogation Request:

The arrival of an LRI is shown in the Navigation Screen (top right hand corner: * 1L)

The detailed LRI is automatically stored in Menu 1:Messages, Submenu: 6 Inbox LRI, where the request can be read and replied to.

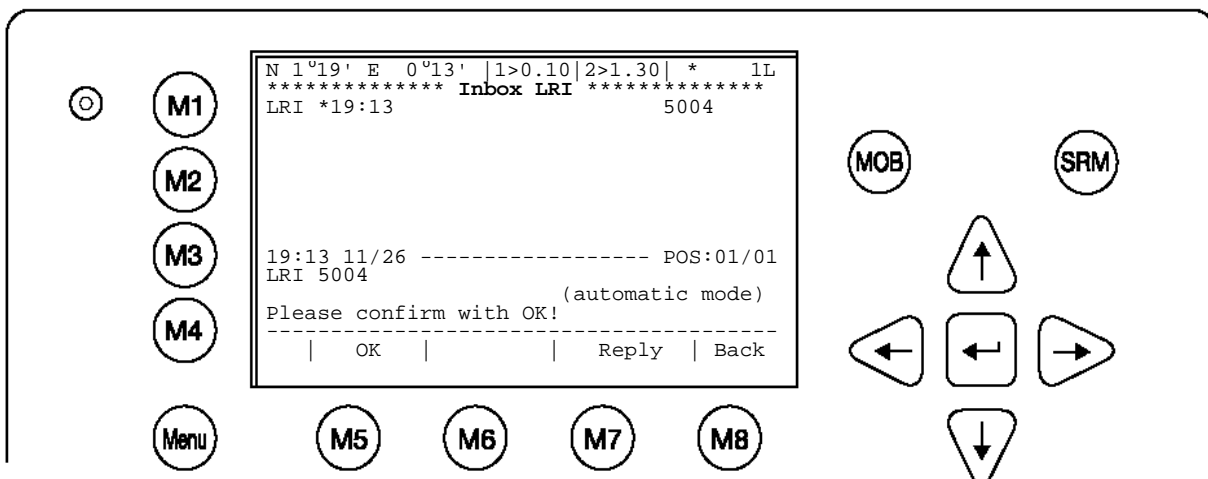
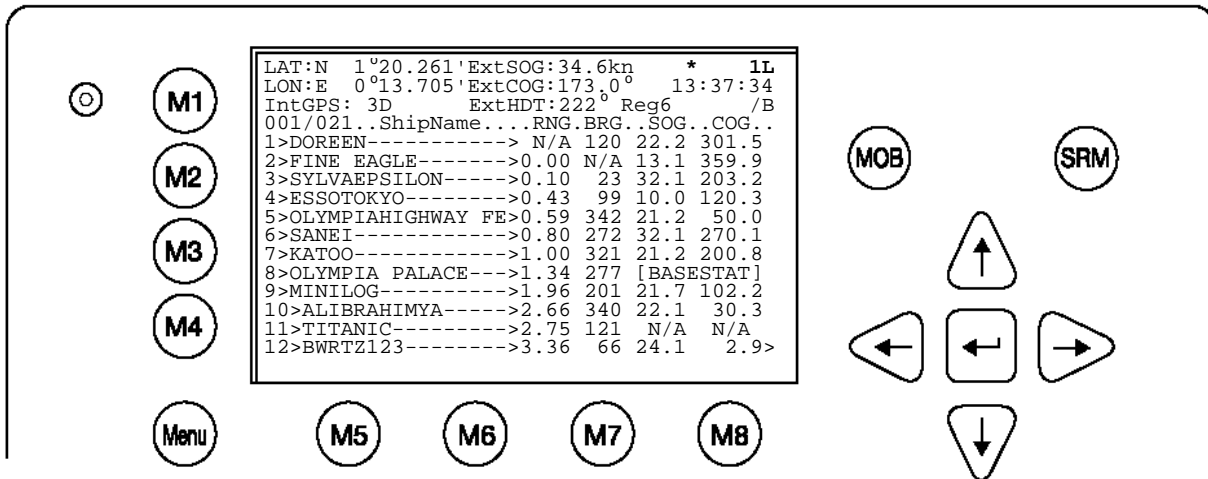

Dynamic Keys: Replying to a LR Interrogation					
[M5]	[OK]	Notifies User of current interrogation	[M8]	[Back]	Return to Vessel Listing
[M7]	[Reply]	Display Message Editor for LRI Reply			

e) Sensor Settings

Within this service password protected menu the NAUTICAST™ offers the following configuration options:

- Set up data speed 4800/9600/38400 baud.
- Monitor the connected sensor inputs for each sensor channel.
- Verify and edit the Sensor Configuration on the display screen.
- Analyze the information received from the connected sensor devices.
- Produce an electronic installation report.
- Configuration of various NMEA protocols.

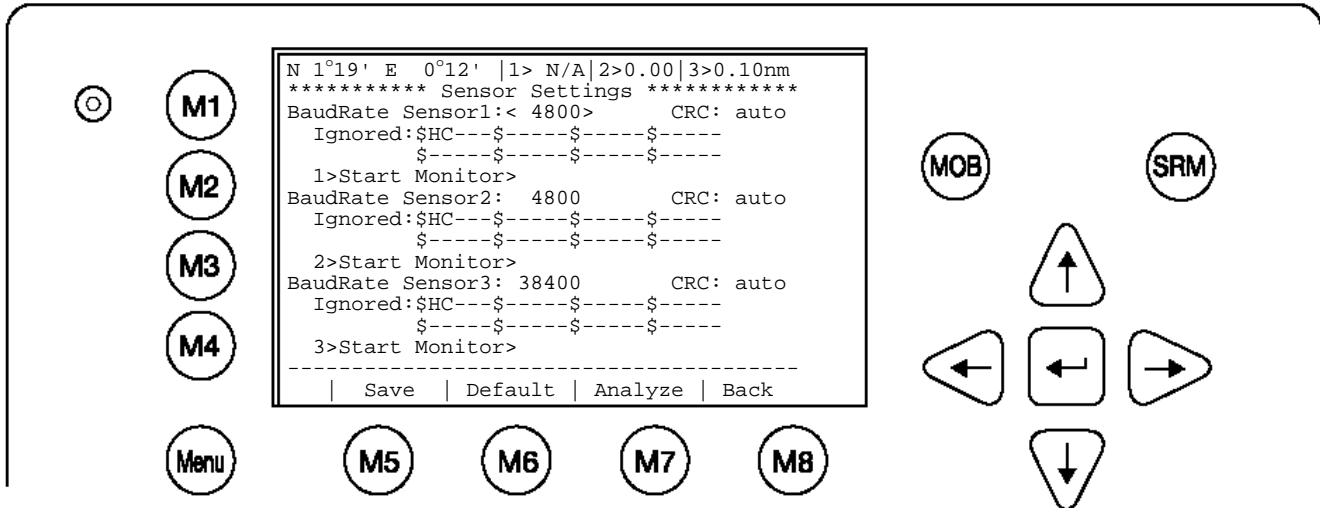

Dynamic Keys: Sensor Settings				
[M5]	[Save]	Save Data Input	[Up] [Down]	/ Select Data Field for Configuration
[M6]	[Default]	Restor the default settings	[Enter]	Select Data Field for Configuration
[M7]	[Analyce]	Analye you NMEA Data stream	[Left] [Right]	/ Configure Data
[M8]	[Back]	Return to Menu Configuration		

Use this menu to set up the data speed 4800/9600/38400 baud.

NOTE: This configuration should be done only by advanced users like installation technicians. Therefore you will find more details in the installation manual.

During the configuration process, the NAUTICAST™ is not operational.

GPS Settings (Service Password protected)

GPS Module:

The NAUTICAST™ shows the inbuilt GPS Module now. It can be '<µBlox>' or '<Jupiter>' You can get the AIS to search again for which GPS Module is installed. Don't select the other type of GPS module, other the internal GPS will not provide a position and your AIS can not operate correct. Select and with the [Left] & [Right] arrows the option <SEARCH>to search which module is installed Please mention the system will restart automatically when saving these setting later. .

Pos.Pinning:

The screen provides the means to switch the position pinning function of the internal GPS receiver <On> and <Off>. For vessels operating with SOG < 0,3 knots it is recommended to switch position pinning **Off**. Otherwise the internal GPS receiver may deliver wrong position information. The data input field is fitted with the recommended default value (<on>). Use [Left] & [Right] arrows for toggling between the two modes of position pinning; the [M5] button is used for saving the settings. **Attention:** The system will be restarted after saving the settings.

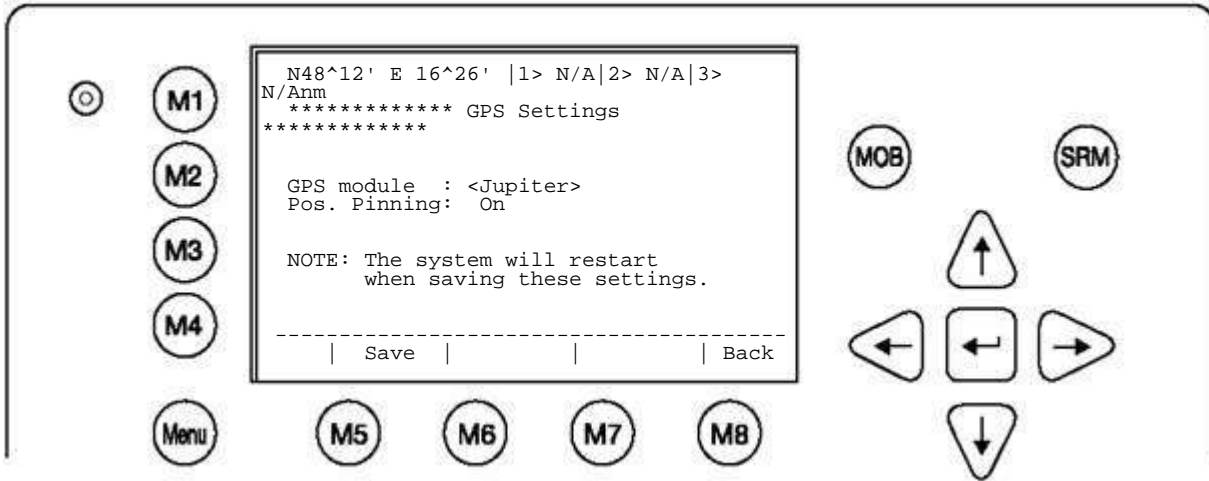

Dynamic Keys: Sensor Settings

[M5]	[Save]	Save Data Input	[M8]	[Back]	Return to Menu Configuration
------	--------	-----------------	------	--------	------------------------------

Inland AIS Configuration / Blue Sign

This screen allows the user to toggle the quality of the speed, course or heading information received from an external device. These settings are normally set to low.

NOTE: It is highly recommended to keep the settings on low.

Blue Sign:

Toggle the value from <not available> to <used> when a Blue Sign switch is connected. Setting the blue sign can be done by an external hardware switch. Please see the Installation Manual on how to connect the blue sign - cable 2635 (NAU-B502)

BlueSign	Blue Sign	<not available> no blue sign switch is connected <used> when a blue sign switch is connected
-----------------	-----------	---

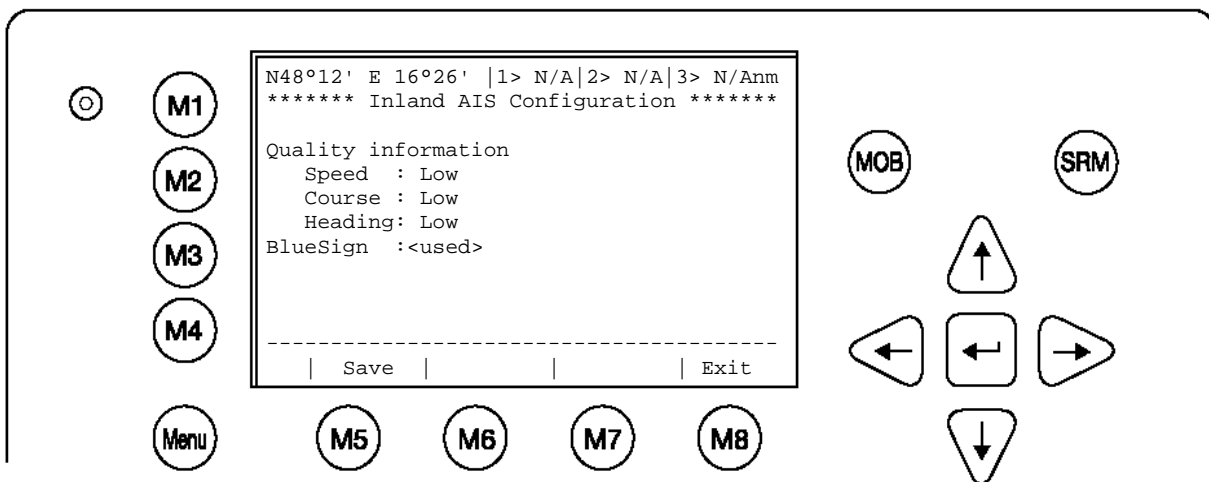

Dynamic Keys: Inland AIS Configuration

[M5]	[Save]	Save Settings	[M8]	[Exit]	Return to Transponder Configuration
------	--------	---------------	------	--------	-------------------------------------

3.5.6 Service Configuration (Service Password Protected)

The Service Configuration Menu allows initial configuration of the Service Password, Password Settings (on/off), MMSI/IMO Numbers and the option of resetting the NAUTICAST™ to Factory Settings.

The Service Password is required in order to enter the Service Configuration Menu. This is a higher security level than can be reached with the User Password and therefore ensures that the Service Configuration is protected, and limited to authorized service personnel.

NOTE: Please see Appendix 7.3 for password information. It is strongly recommended to change the service password immediately after commencing initial NAUTICAST™ operation!

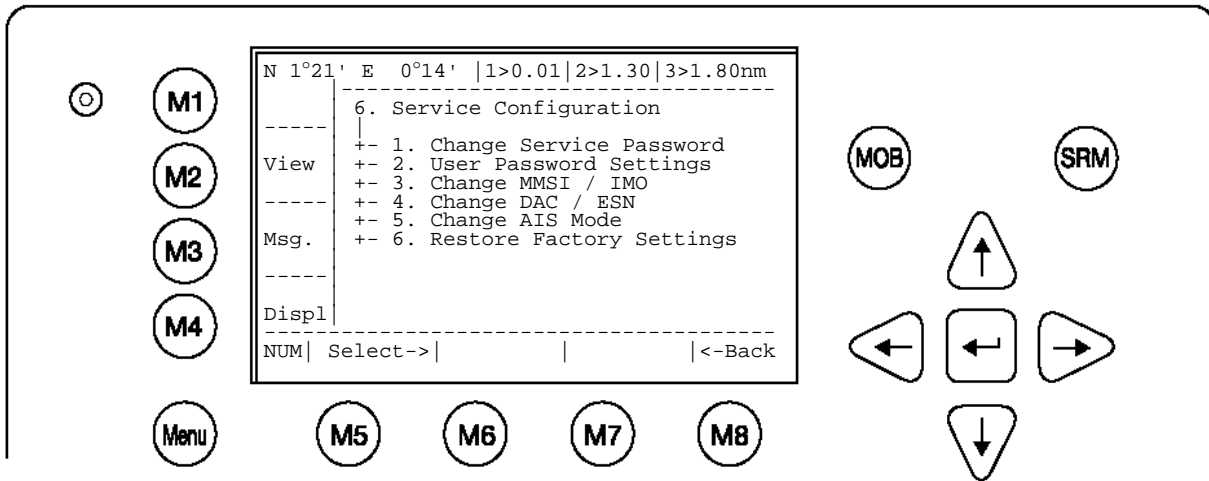

Dynamic Keys: Service Configuration						
[M5]	[Select]	Confirm Selection	Submenu	[Enter]	Confirm Selection	Submenu
[M8]	[Back]	Return to Main Menu				

After entering the Default Service Password (**Please see Appendix 7.3 for password information**) in the password query, the Service Configuration Menu may be accessed. In this menu it is possible to configure both the Service Password and the User Password Settings, as well as input the MMSI/IMO Numbers and reset the to Factory Settings.

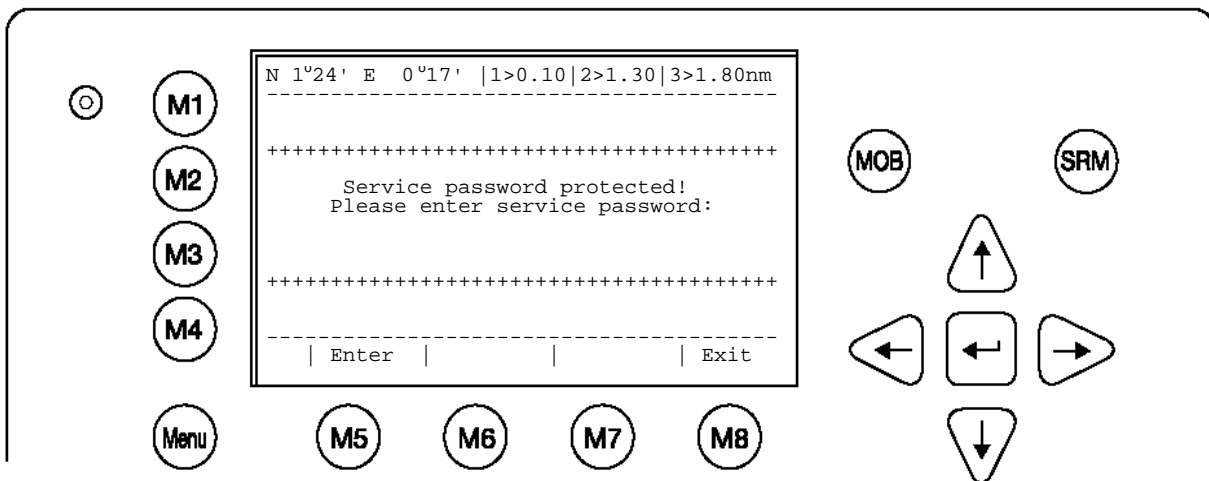

f) Change Service Password

This screen provides a means to individually configure the Service Password. This password differs from the User Password as it allows the user access to the Menu „Service Configuration“.

A minimum of 6, a maximum of 8 characters are allowed. The process of configuring the Service Password is identical to that of User Password configuration (see Menu 5: Configuration, Submenu 1: Change User Password).

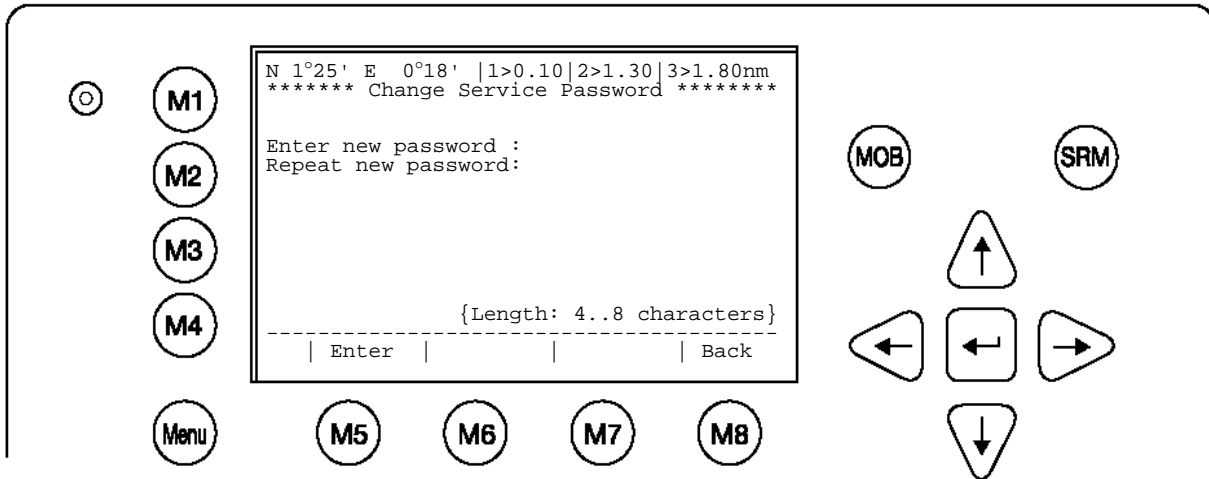

Dynamic Keys: Change Service Password				
[Enter]	Confirm New Service Password Input	[M8]	[Back]	Return to Submenu Service Configuration
[Save]	Save New Service Password			

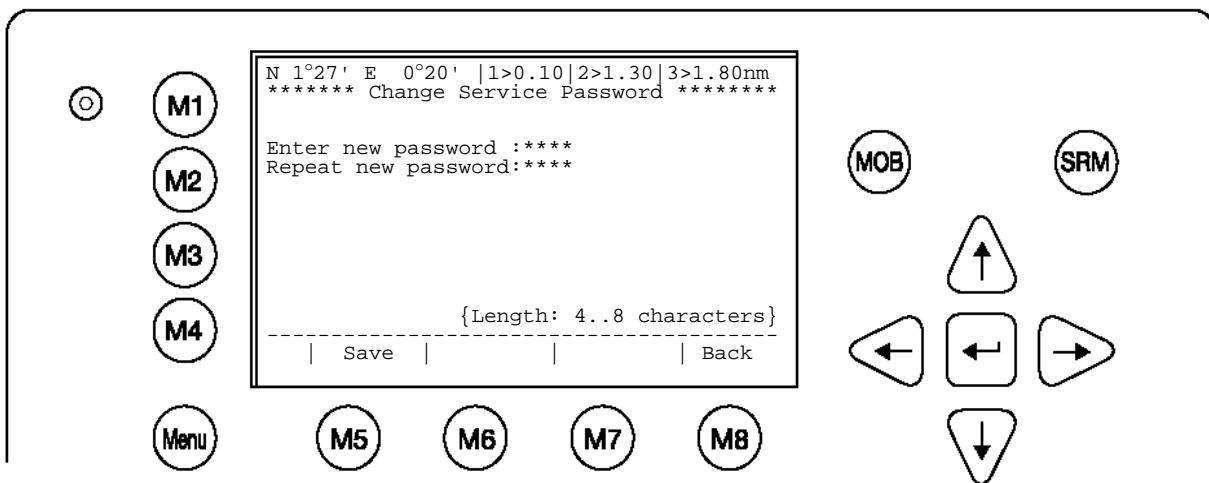

Dynamic Keys: Change Service Password				
[Save]	Save New Service Password	[M8]	[Back]	Return to Submenu Service Configuration

g) User Password Settings

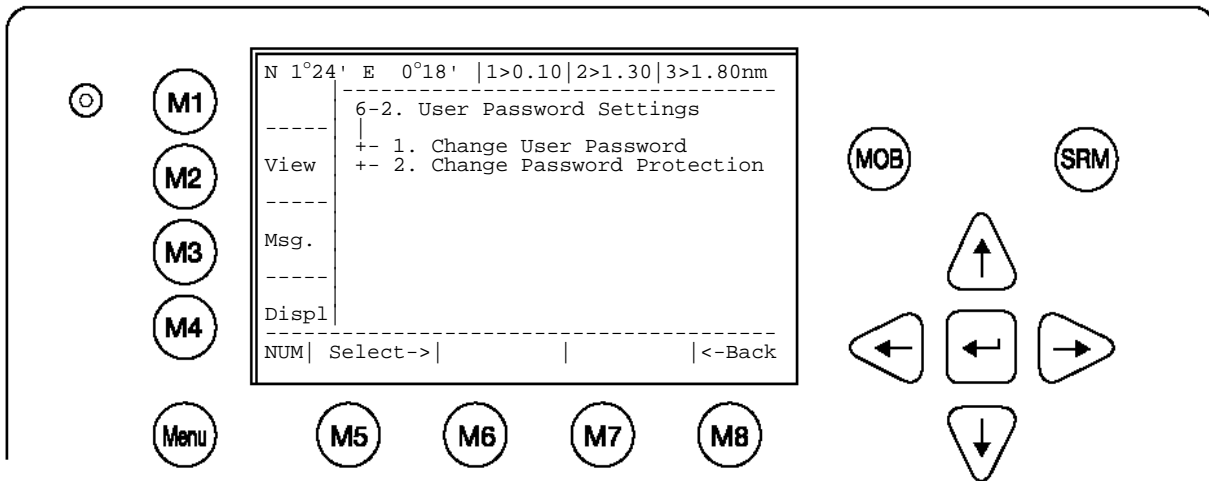

Change User Password Protection:

This function allows the user to enable or disable the User Password Query Function. For security reasons, it is highly recommended to enable User Password Protection in order to avoid unauthorized Transponder operation.

After the settings have been input and saved, the Data Saved Screen confirms the new configuration.

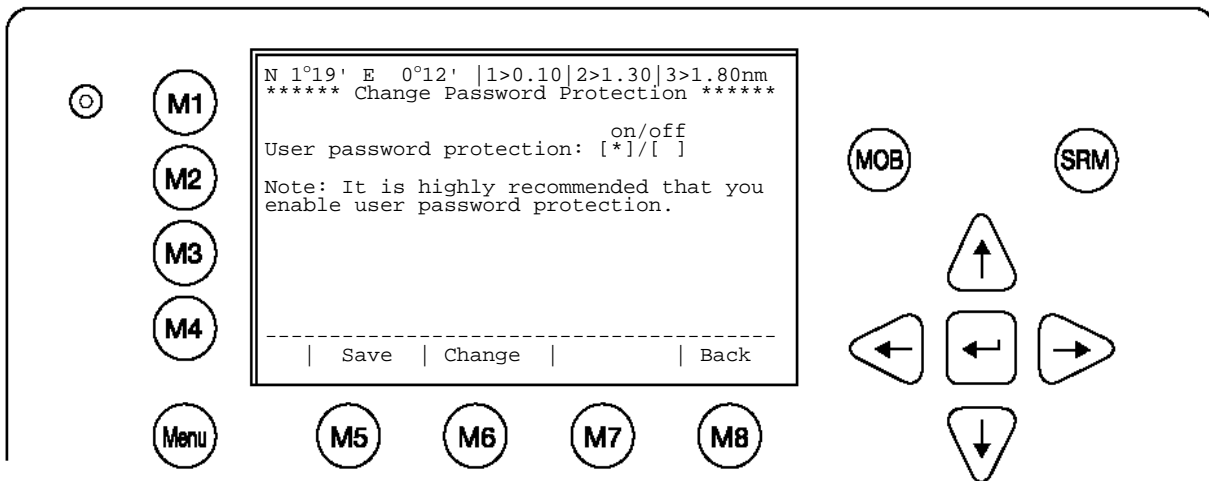

Dynamic Keys: Change User Password Protection				
[M5]	[Save]	Save User Password Setting	[Enter]	Save User Password Setting
[M6]	[Change]	Configure Password Setting (on/off)	[Right] / [Left]	Configure Password Setting (on/off)
[M8]	[Back]	Return to Submenu User Password Settings		

h) Changing the MMSI / IMO / DAC / ESN Numbers

Mentioned DAC and ESN numbers are only available in Inland AIS - Mode .

Select again “Service Configuration” from the Main Menu with the cursor button [Up] & [Down] or press No. 6 on the keyboard.

Select Submenu 3 “Change MMSI/IMO” with cursor button [Up] & [Down] by pressing No. 3 on the keyboard.

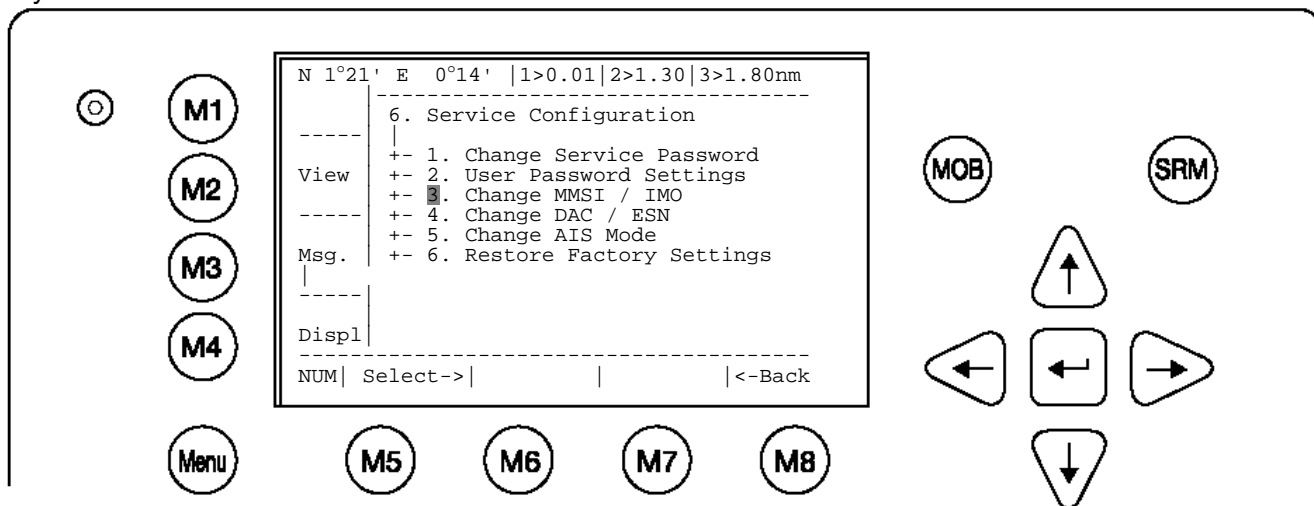

Input new MMSI / IMO Numbers and press [Save] to store input data. Press [Back] to return to the Submenu without saving.

NOTE: Data input is limited to 9 characters. Once you’ve keyed in a new MMSI and pressed the “Save” – button, the NAUTICAST™ will restart automatically. After restarting come back to the “Service Configuration” Menu to complete the settings (DAC, ESN and AIS-Mode).

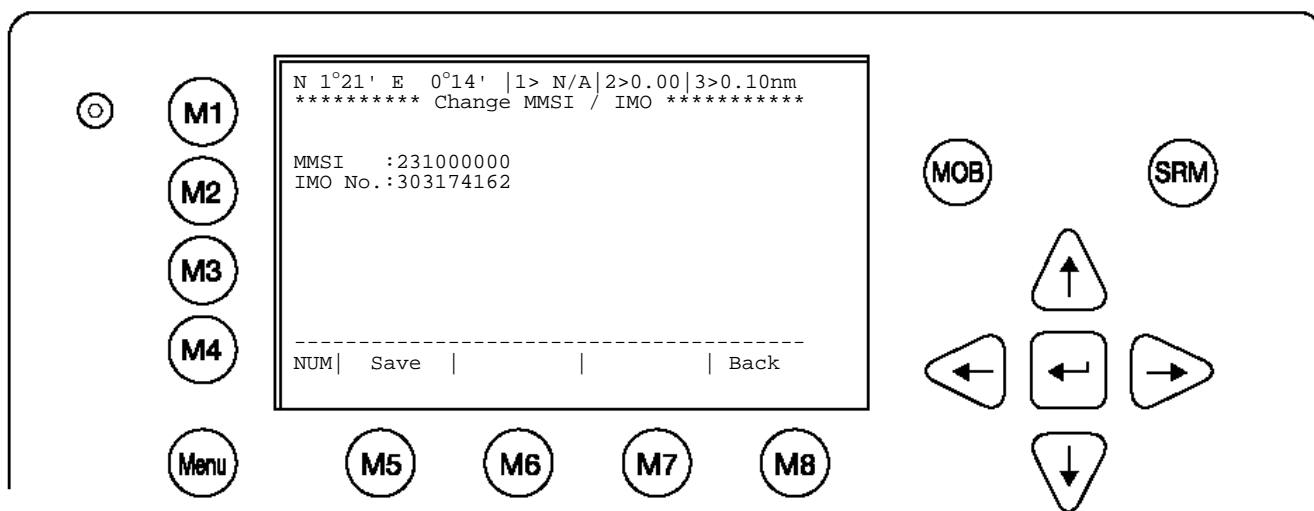

Select Submenu 4 “Change DAC / ESN” with cursor button [Up] & [Down] by pressing No. 4 on the keyboard.

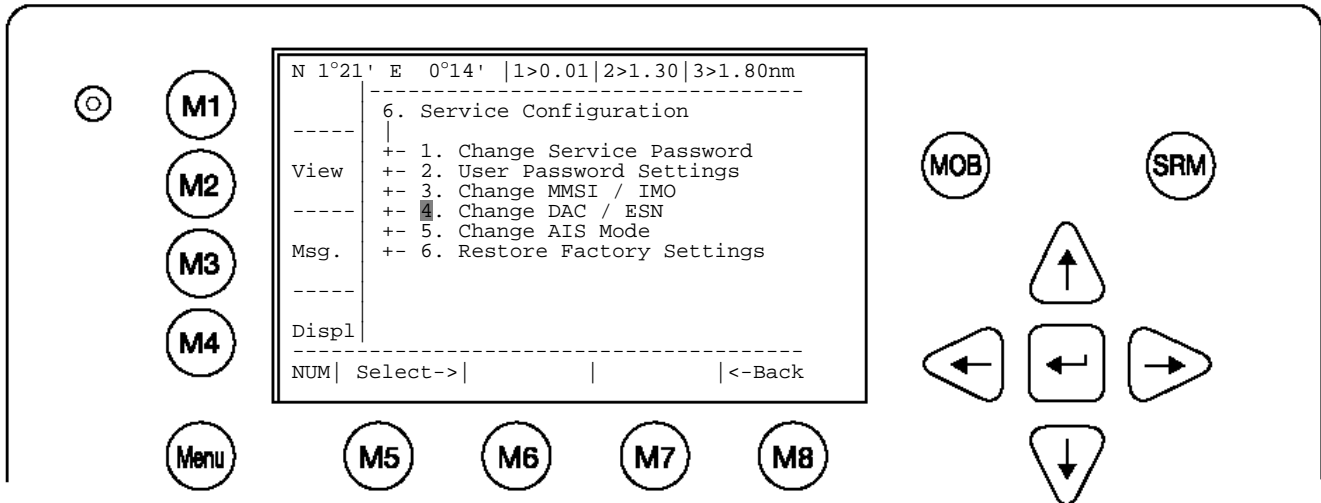

Input new DAC / ESN Numbers and press [Save] to store input data. Press [Back] to return to the Submenu without saving.

NOTE: The DAC (Designated Area Code) is predefined with the value “200”. Please key in only a different 3 digit value if your authority wants you to do this. Otherwise you may lose important AIS information. The ESN (European Ship Number) is limited to 8 ASCII characters.

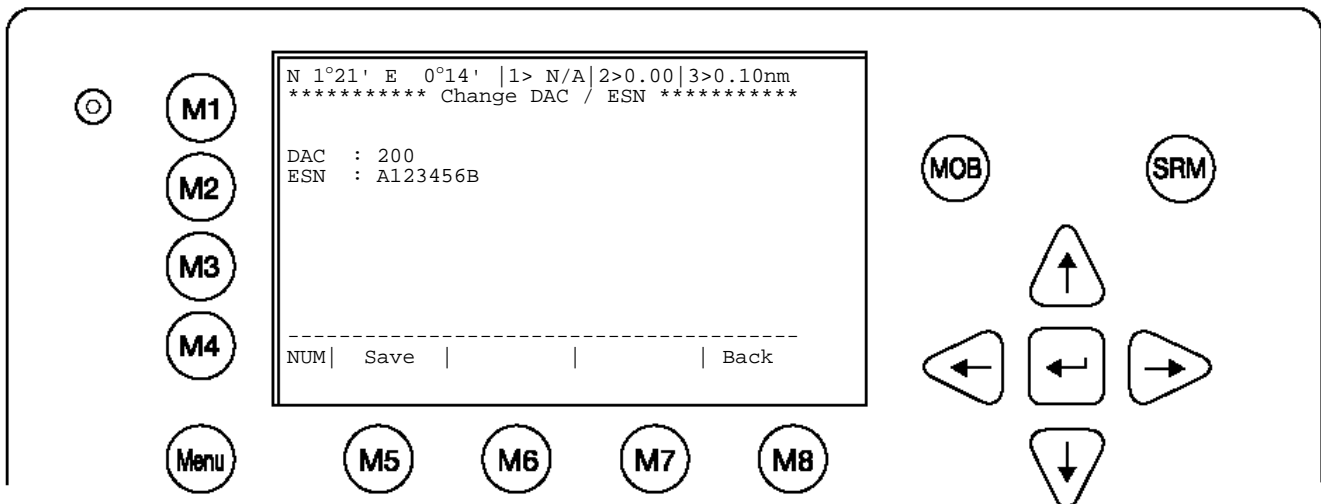

Dynamic Keys: Change MMSI / IMO				
[M5]	[Save]	Save MMSI/IMO Number Input	[Enter]	Navigate Data Input Fields (up/down)
[M8]	[Back]	Return to Submenu Service Configuration	[Up] / [Down]	Navigate Data Input Fields (up/down)

i) Changing the AIS Mode

Select "Service Configuration" from the Main Menu with the cursor button [Up] & [Down] or press No. 6 on the keyboard.

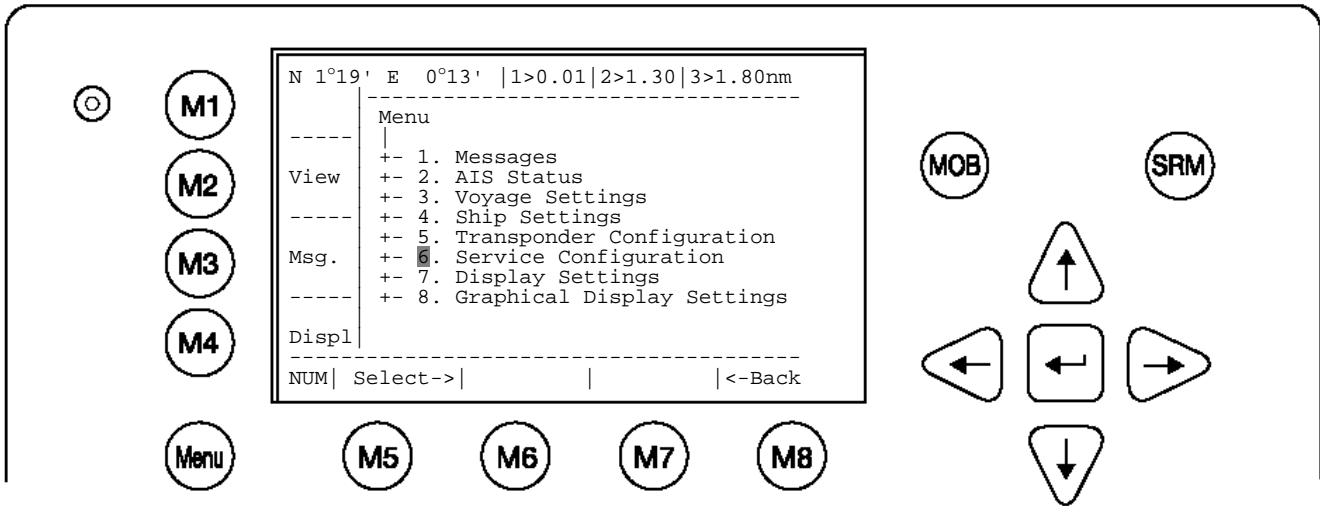

Input Service Password and press [Enter].

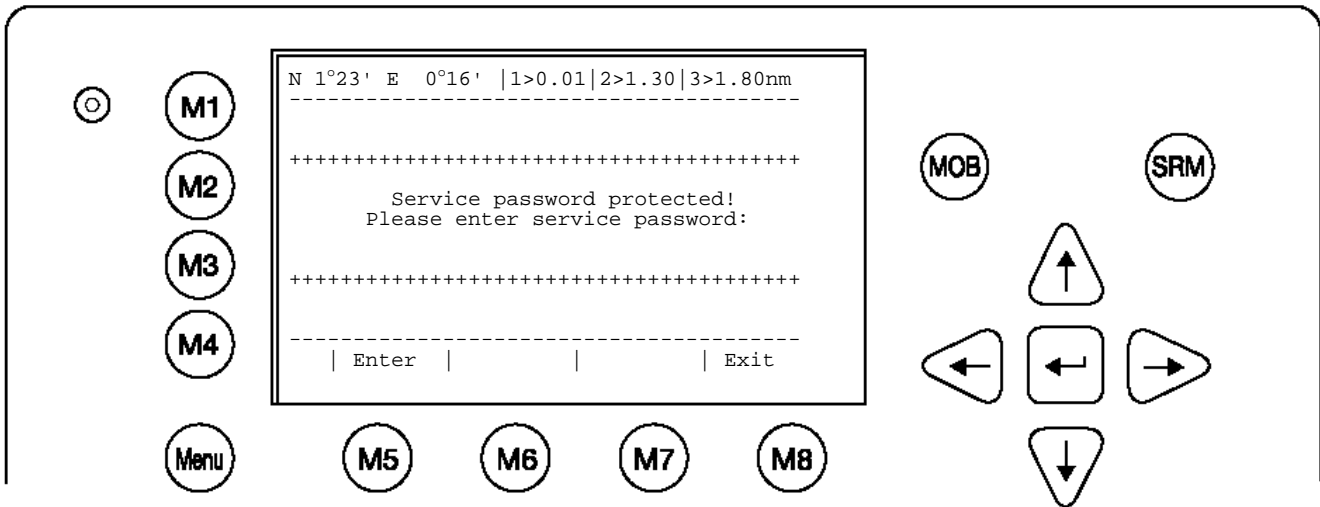

Select Submenu 5 “Change AIS Mode” with cursor button [Up] & [Down] by pressing No. 5 on the keyboard.

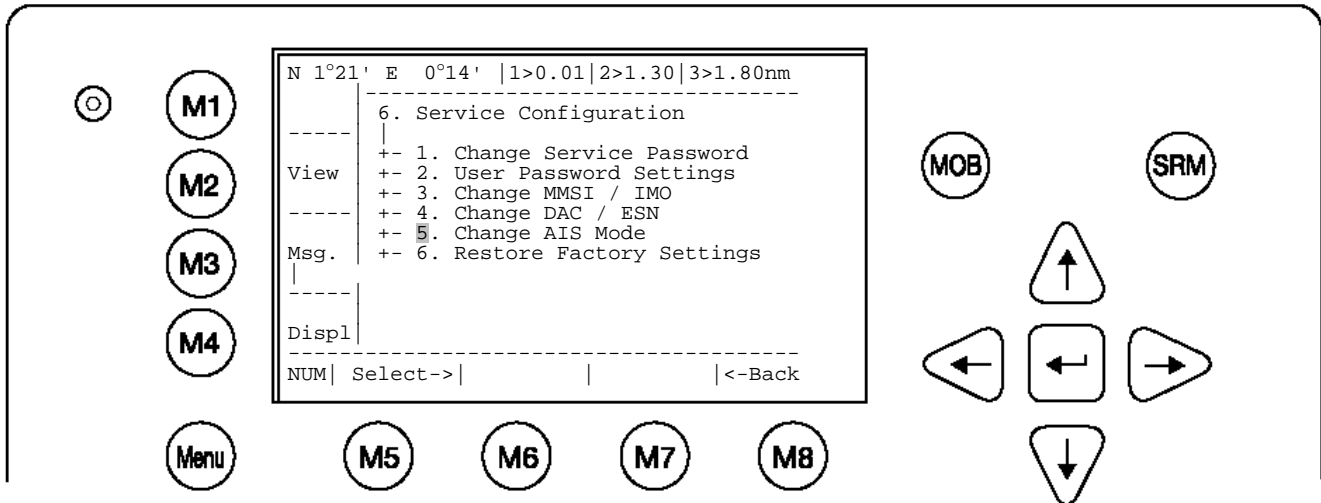

Toggle the AIS Mode between the configurations of “High Seas” and “Inland AIS”. Main parts of the technical performance of the NAUTICAST™ are in relation to this setting. In the “High Seas” mode menu will have different appearance. Toggle the values you want to use and press [Save] to store input data. Press [Back] to return to the Submenu without saving.

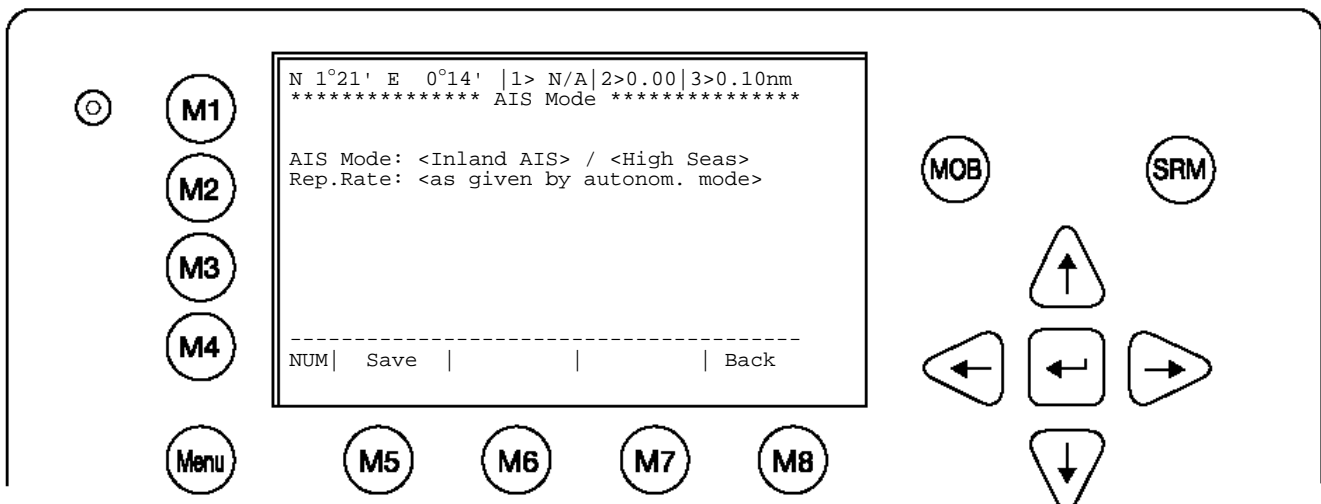

NOTE: Changes of the reporting rate setting should be done very carefully.

Possible reporting rate values are: “as given by the autonomous mode”; “once every 10 minutes”; “once every 6 minutes”; “once every 3 minutes”; “once every minute”; “once every 30 seconds”; “once every 15 seconds”; “once every 10 seconds”; “once every 5 seconds”; “next higher reporting rate”; “next lower reporting rate”; “once every 2 seconds”

j) Restore Factory Settings

CAUTION: By acknowledging the return to Factory Settings Command, all previous settings, both the User and Service Passwords and all manually input data are automatically deleted!

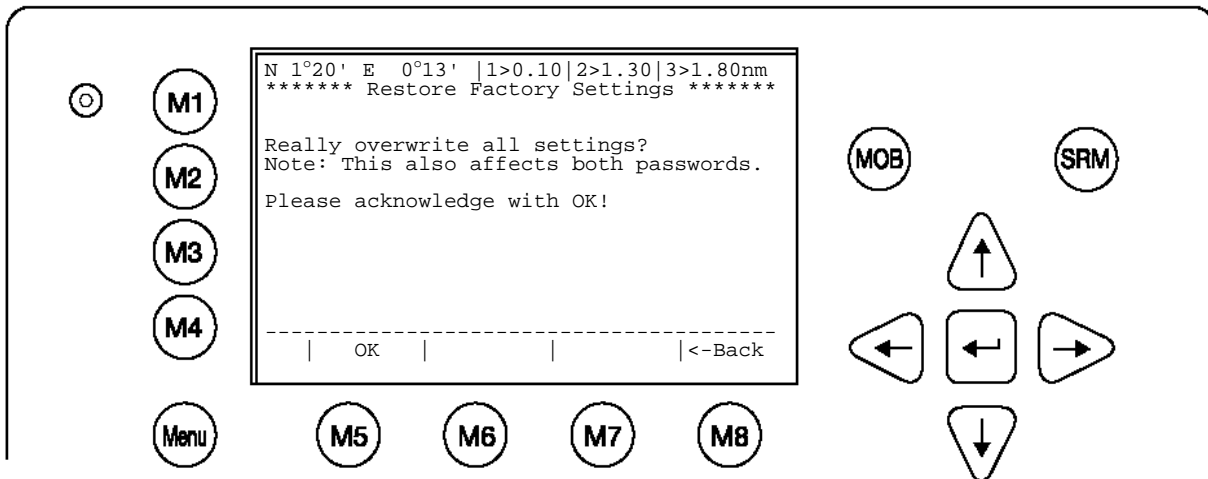

After pressing [OK] - button, the NAUTICAST™ will restarts automatically and restore the factory settings! It starts with following screen:

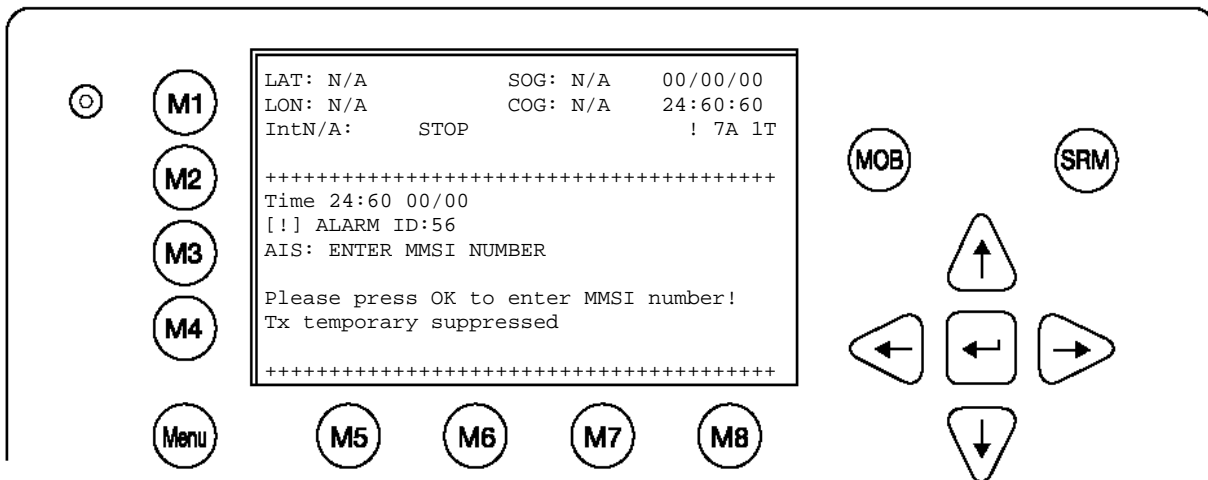

NOTE: The NAUTICAST™ has been restored to the Factory Settings! Now please configure your:

- **MMSI Number**
- **Ship Settings**
- **Voyage Settings**
- **User Password**
- **Service Password**

3.5.7 Display Settings

It is possible to choose from Daylight and Nightlight Display Settings; it is further possible to adjust the Brightness and Contrast Settings for both Display Settings.

The maximum setting for Brightness and Contrast is <9>, the minimum setting is <0>.

It is possible to automatically switch the Display Settings on the NAUTICAST™ to Day or Night Settings from any Menu Screen by pressing the [M4] [Disp] button.

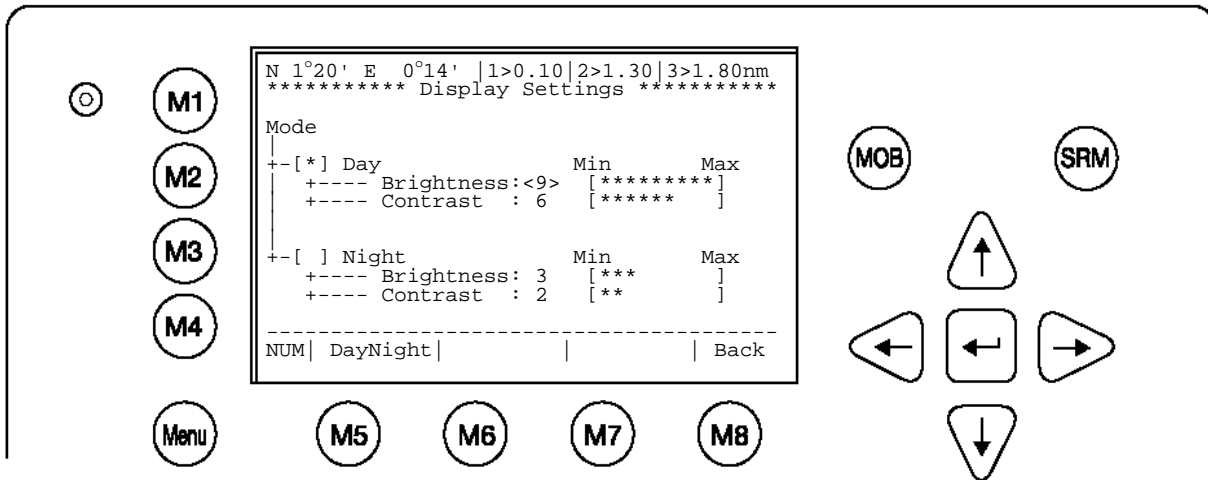

Dynamic Keys: Display Settings				
[M5]	[DayNight]	Switch between Day or Night Settings	[Enter]	Switch between Day or Night Settings
[M8]	[Back]	Return to Main Menu	[Up] / [Down]	Navigate Input Fields
			[Left] / [Right]	Regulate Modes (min/max)

NOTE: The Brightness and Contrast Setting can be directly changed from the keyboard by inputting the desired value.

3.6 Graphical User Interface (GUI)

The advanced version of the NAUTICAST™ is fitted with the new Graphical User Interface. The intention of this interface is to enable the operator to visualize any AIS traffic, which is traveling around the own position. Fast and direct access to AIS data is supported by display of a list containing vessel information, which can be reached directly from the Navigation Screen and viewed in two views (radar and fairway orientations). The NAUTICAST™ display is limited in resolution and size and should therefore be used as an additional information source only. The Navigation Screen (without the graphical information) remains the most relevant information source. The GUI is only visible in the advanced version of the NAUTICAST™ (software version 2.0.1.0 or higher).

NOTE: The Automatic Identification System (AIS) provides additional information from AIS equipped vessels only. The intentions of the new views are to visualize this AIS data for better and faster access to the ship details.

The main features of this Graphical User Interface (GUI) are the two new view options:

- Radar View
The typical way of presenting traffic information on screens
- Fairway View
This type of view is oriented to the current course over ground (COG) and supports the operator with information related to this particular region

Remarks

- In both views it is possible to zoom in and out to get more detail or a better overview of the visual content.
- Additionally, it is possible to change the target (own & other vessel) symbols to fit personal requirements in both views.
- To receive further information on a specific target it can be selected by using the cursor keys.
- Messages will be displayed on the GUI. Writing answers to messages is done by automatically transferring to the Navigation Screen structure.
- The function keys remain unchanged in the GUI.

Dynamic Keys: graphical user interface	
[M1]	filter option on AIS targets in graphical view <ul style="list-style-type: none"> • FA (hides received Class A targets) • FB (hides received Class B targets)
[M2]	Switch between the views from the Navigation Screen press the button the 1 st time will lead you to the Radar View press it the 2 nd time will lead you to the Fairway View press it the 3 rd time will bring you back to Navigation Screen
[M3]	Show alarm windows
[M5]	Acknowledge alarms or safety related messages (SRM)
[M7]	Acknowledge SRM and Reply
[Menu]	Selects the Main Menu
[FN] + [Up] / [Down]	Changes the Zoom Level
[Shift]+ [Up] / [Down] /	Scrolls the view (only in radar view available)

3.6.1 Switching between the Views

Navigation Screen

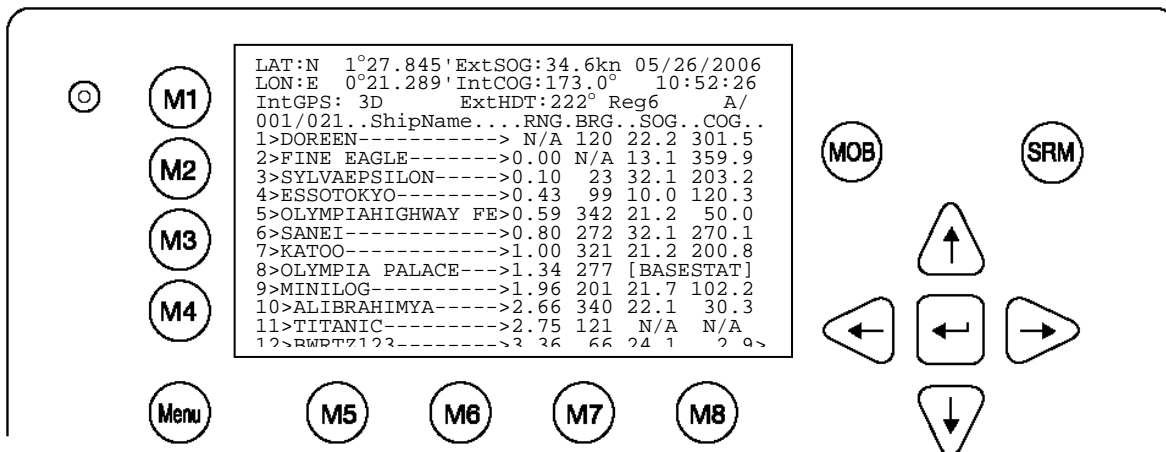

pressing [M2] leads to Radar View

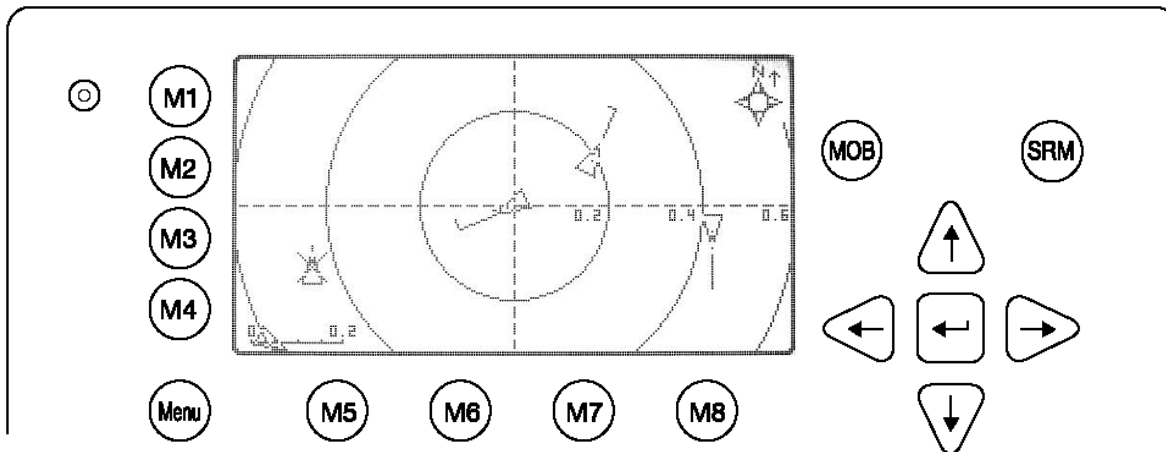

pressing [M2] leads to Fairway View

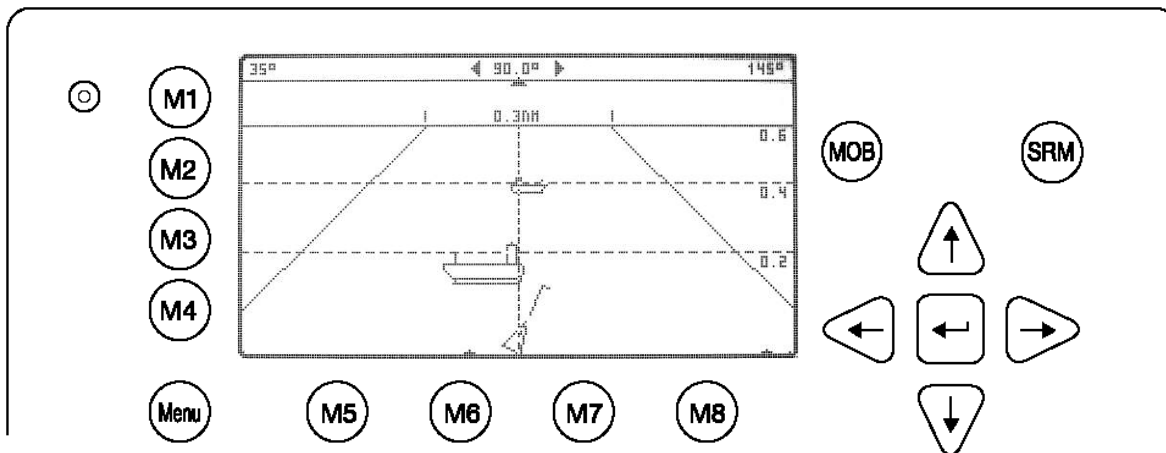

pressing [M2] leads you back to Navigation Screen

3.6.2 The Radar View

This screen provides the user with a commonly used way of representing ship objects on an electronic device. The Radar View is northern orientated, as indicated by the compass on the very right top of the screen.

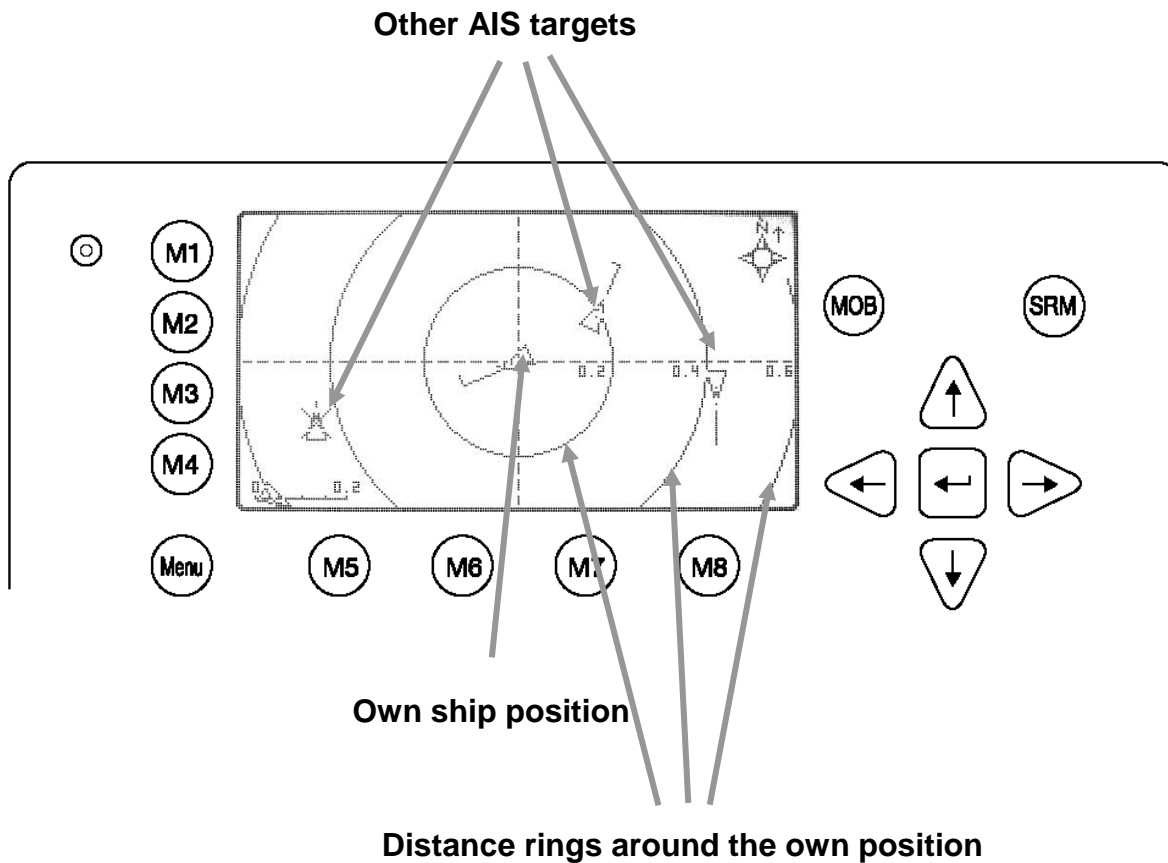

The Elements of the Radar View:

Own Ship:

A symbol for the own ship is displayed in the middle of the screen. This can be changed by scrolling through the window (for detailed description see later chapter) 0.

AIS-Targets:

Other AIS-Targets received within VHF range are displayed as long as they fit in the current zoom level. They are displayed according to their current heading.

Distance Rings:

The distance rings are marked in nautical miles according to the current zoom level.

Symbol Representation:

There is a choice of personalized symbols for the own ship, as well as symbols for the other AIS-targets. (For symbol selection refer to chapter **Error! Reference source not found.**).

Dynamic Keys: Radar View	
[M1]	Set filter option on AIS Targets
[M2]	Switch between the views
[M3]	Show alarm window
[M5]	Acknowledge alarms or safety related messages (SRM)
[M7]	Acknowledge SRM and reply
[Menu]	Selects the Main Menu
[Up] / [Down] / [Left] / [Right]	Activate the minimized radar view
[FN] + [Up] / [Down]	Change the zoom level
[Shift]+ [Up] / [Down] /	Scroll the view (only available in radar view)

Zoom Levels

To adjust the Radar View following zoom levels are implemented (default is zoom level 4):

Radius	ZOOM LEVEL							
	1	2	3	4	5	6	7	8
Outer Ring [nm]	0,3	0,6	1,5	3	7,5	15	30	45
Middle Ring [nm]	0,2	0,4	1	2	5	10	20	30
Inner Ring [nm]	0,1	0,2	0,5	1	2,5	5	10	15

← zoom in / zoom out →

The zoom level could be changed by pressing [FN] + [Up] to zoom in (more details, less geographical coverage) and [FN] + [Down] to zoom out (less details, more geographical coverage)

Zoom level 2 would look like this:

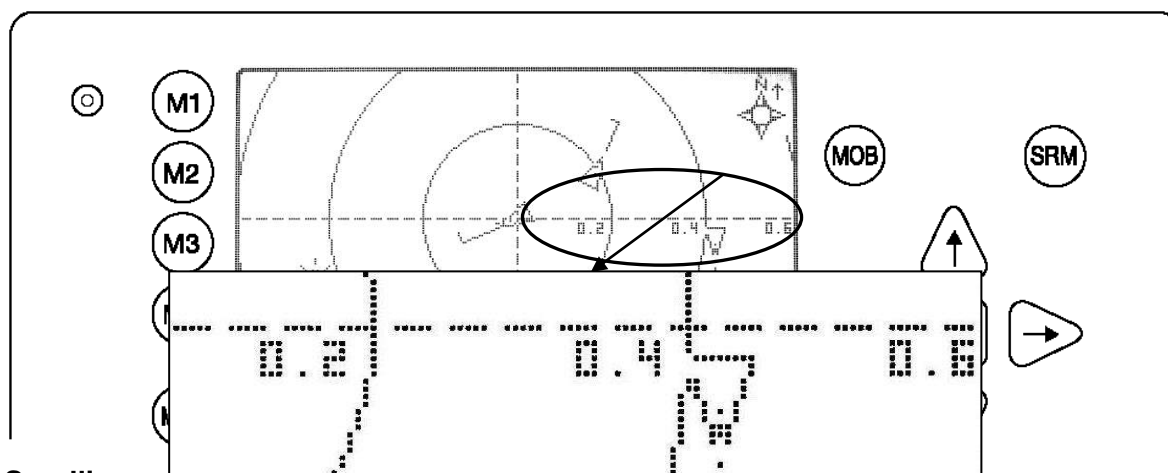

Scrolling

Since the outer distance ring does not completely fit into the (rectangle) display, it is possible to scroll the view from North or South. The maximum scrolling distance is limited to the radius of the outer distance ring in the current zoom level. The view can be scrolled by 2 steps in each direction.

The view can be scrolled by pressing [Shift] + [Up] to scroll towards North and [Shift] + [Down] to scroll towards South

This screen shows a 1 step scrolling in a northern direction.

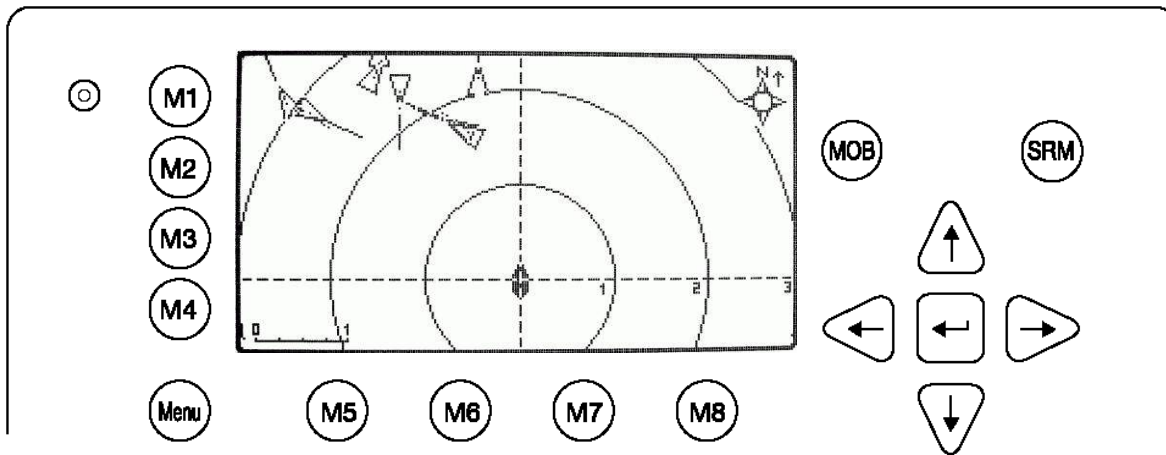

This screen shows a 1 step scrolling in a southern direction.

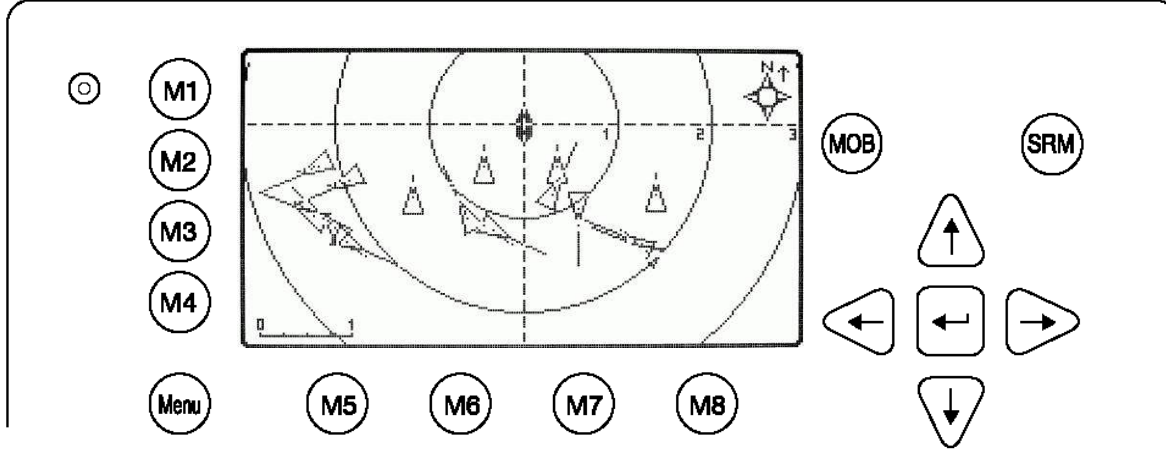

This screen shows a 2 step scrolling in a southern direction.

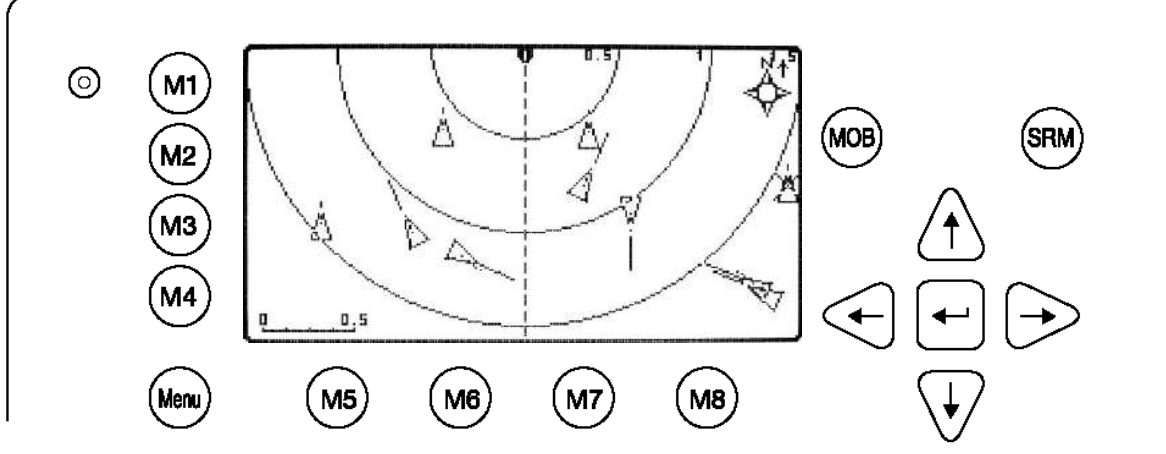

The Minimized Radar View

The minimized radar view shows a split screen. On the left hand side a Ship List is displayed, on the right hand side a minimized view of the Radar View is visible. This view will be displayed, if one of the cursor keys is pressed. The difference between the minimized, and the large view options are that the minimized view shows the maximum in both North and South direction, since scrolling is NOT possible.

Radar View → [Up] | [Down] | [Left] | [Right] → Minimized Radar View

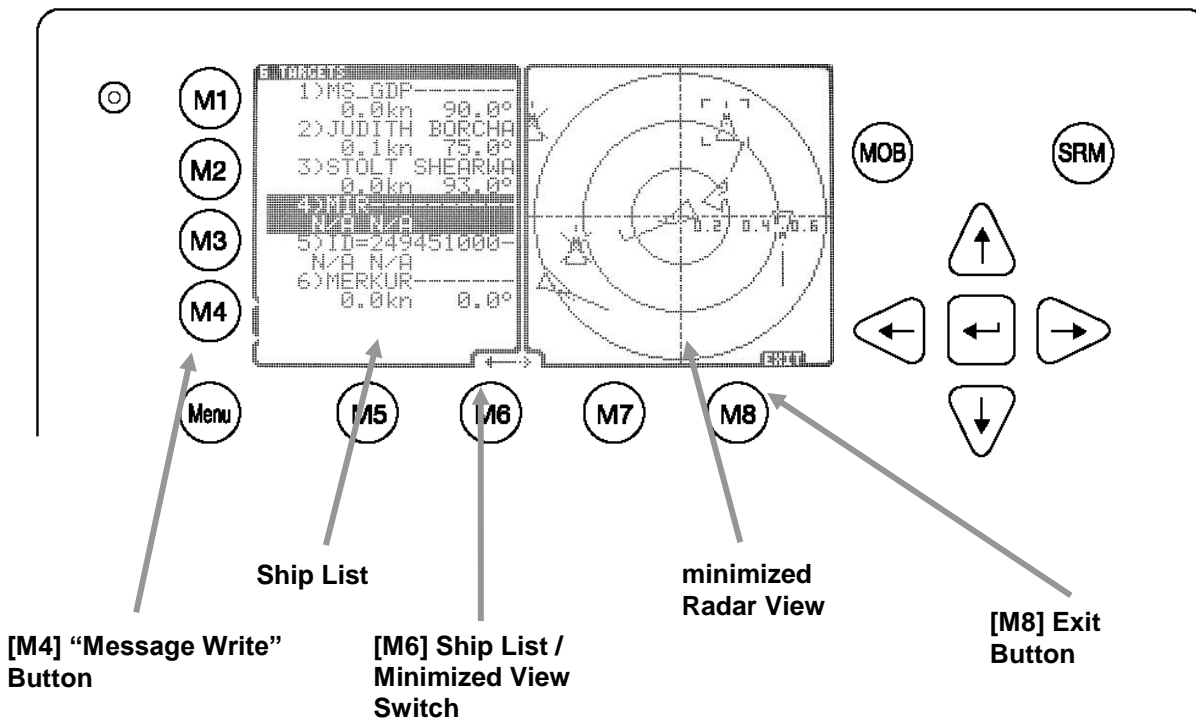

The Elements in the Minimized Radar View:

“Message Write” Button:

By pressing the [M4] button, a message can be sent to an AIS target that is currently selected in the Ship List.

Ship List:

This list shows the same targets as shown in the Navigation Screen.

Ship List / Minimized View Switch:

This switch indicates whether targets can be selected from the Ship List or from the minimized view. If the arrow above the [M6] points to the left, targets can be selected from the Ship List with the [Up] and [Down] buttons. If the above arrow points to the right, targets can be selected from the minimized view with the [Up] or [Down] or [Left] or [Right] buttons. Regardless on which side of the screen targets are selected, both views correspond to each other.

Minimized View:

This view is the minimized representation of the normal Radar View. Zoom in/out is also possible in the Minimized Radar View

Exit Button:

The exit button returns the user to the Radar View.

Ship Details

If a target is selected by pressing [Enter], whether in the Ship List or directly in the graphical view, the corresponding ship details are displayed instead of the minimized view.

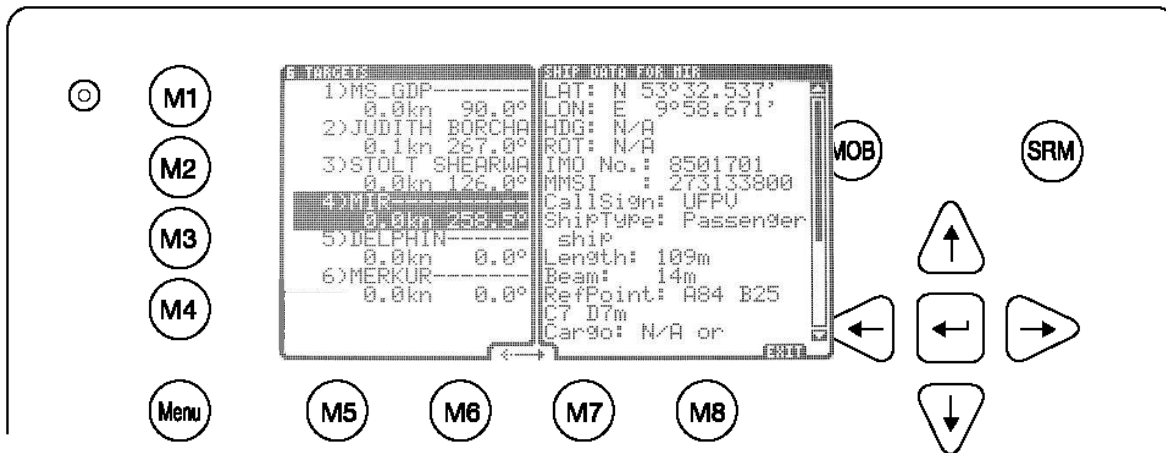

Pressing [Up] or [Down] scrolls the ship detail list by line, [Left] or [Right] by page. [M8] returns to the minimized view.

3.6.3 The Fairway View

The Fairway View shows the course over ground (COG) orientated view of the Information screen data.

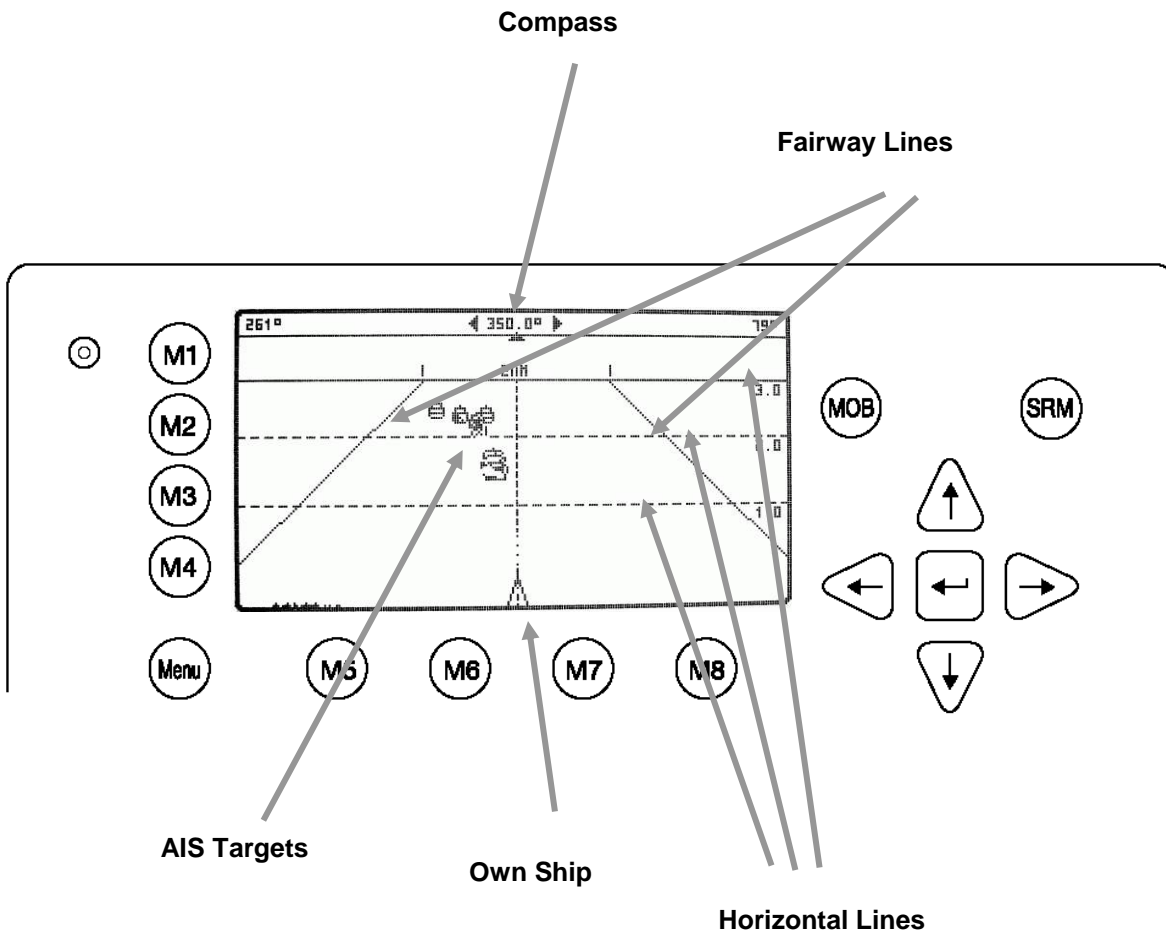

The Elements in the Fairway View:

Compass:

Shows the current COG.

Fairway Lines:

The Fairway Lines are border lines of a virtual fairway oriented on the actual course over ground.

AIS-Targets:

Other AIS targets received via VHF are displayed, if their distance is within the range of the current zoom level.

Own Ship:

A symbol for the own ship is displayed in the middle of the screen and can not be changed.

Horizontal Lines:

The horizontal lines are the equivalent to the radar views distance rings.

Dynamic Keys: Fairway View	
[M1]	Set filter option on AIS targets
[M2]	Switch between the views
[M3]	Show alarm windows
[M5]	Acknowledge alarms or safety related messages (SRM)
[M7]	Acknowledge SRM and reply
[Menu]	Select the Main Menu
[Up] / [Down] / [Left] / [Right]	Activate the minimized radar view
[FN] + [Up] / [Down]	Change the zoom level

Zooming

The following zoom levels are implemented for adjusting the Fairway View (default is zoom level 4):

Radius	ZOOM LEVEL							
	1	2	3	4	5	6	7	8
Outer Ring [nm]	0,3	0,6	1,5	3	7,5	15	30	45
Middle Ring [nm]	0,2	0,4	1	2	5	10	20	30
Inner Ring [nm]	0,1	0,2	0,5	1	2,5	5	10	15

← zoom in / zoom out →

The zoom level can be changed by pressing

[FN] + [Up] to zoom in (more details, less geographical coverage) and

[FN] + [Down] to zoom out (less details, more geographical coverage)

Zoom Level 2 would look like this:

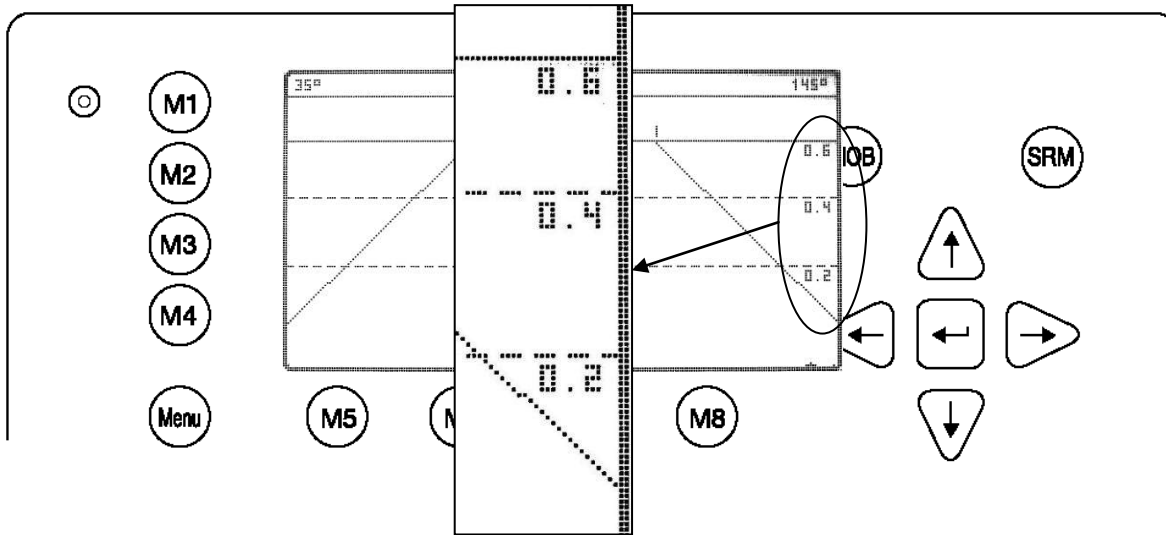

The Minimized Fairway View

The minimized Fairway View shows a split screen. On the left hand side a Ship List is displayed and on the right hand side a minimized Fairway View is seen. This view is displayed, if one of the cursor keys is pressed.

Fairway View → [Up] | [Down] | [Left] | [Right] → Minimized Fairway View

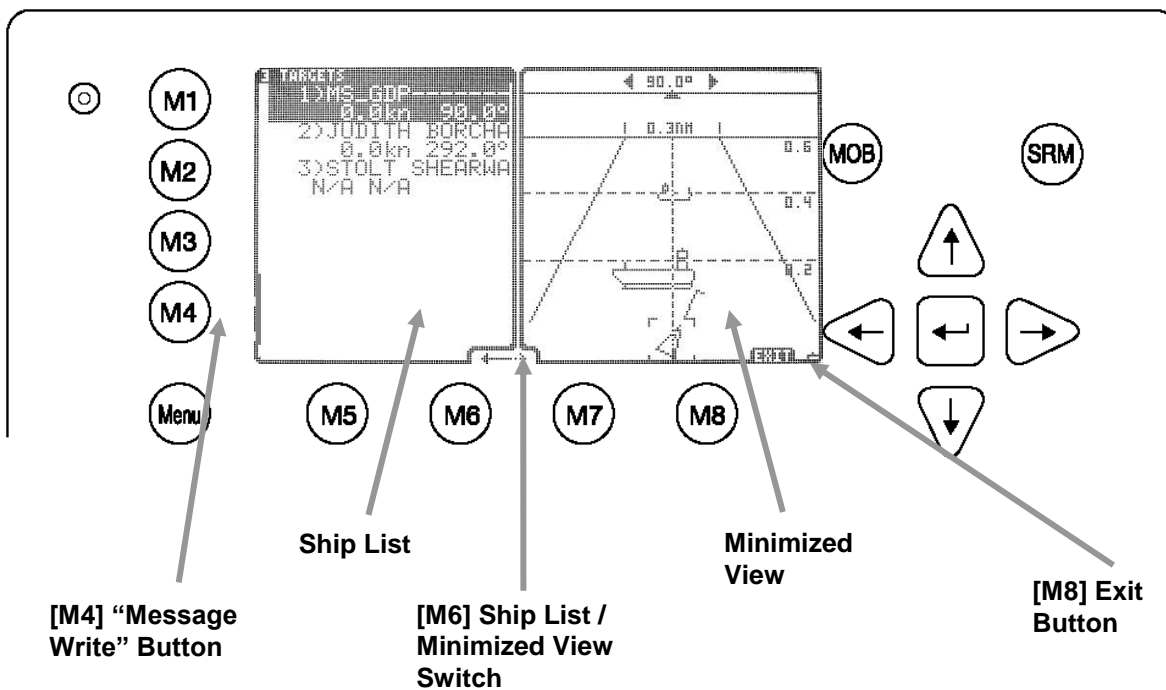

The Elements in the Minimized Fairway View:

“Message Write” Button:
By pressing the [M4] button, a message could be sent to that AIS-Target that is currently selected in the Ship List.

Ship List:
This list shows the same targets as shown in the Navigation Screen.

Ship List / Minimized View Switch:

This switch indicates whether targets can be selected from the Ship List or from the minimized view. If the arrow above the [M6] points to the left, targets can be selected from the Ship List with the [Up] and [Down] buttons. If the arrow above points to the right, targets can be selected from the minimized view with the [Up] or [Down] or [Left] or [Right] buttons. Regardless on which side of the screen targets are selected, both views correspond to each other.

Minimized View:

This view is the minimized representation of the normal Radar View. Zoom in/out is also possible in this view.

Exit button:

The exit button returns the operator to the Radar View.

Zooming is also possible in the Minimized Fairway View.

Ship Details

If a target is selected, whether in the Ship List or directly in the graphical view, the corresponding ship details are displayed instead of the minimized view.

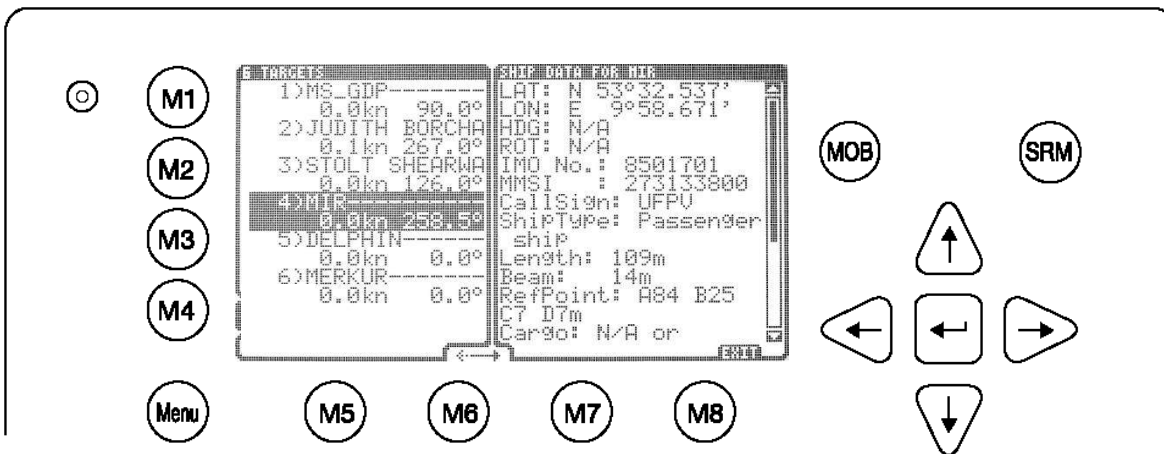

Pressing [Up] or [Down] scrolls the ship detail list by line, [Left] or [Right] by page. [M8] returns to the minimized view.

3.6.4 Message and Alarm Handling

Alarms

If an alarm occurs, the symbol to the right of the [M3] button becomes visible.

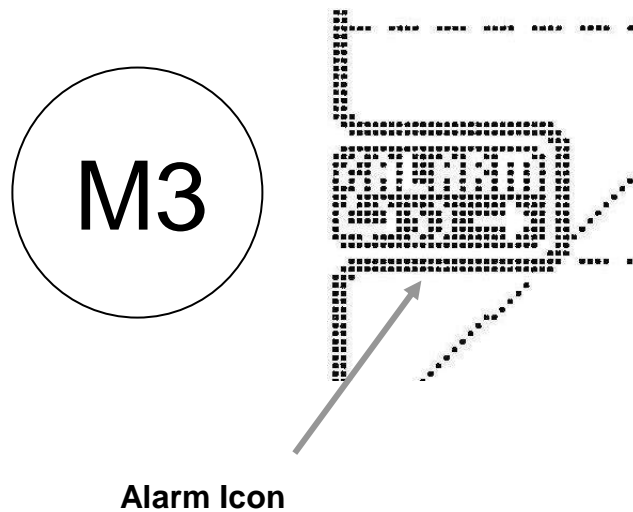

Pressing the [M3] button shows the details of the selected alert.

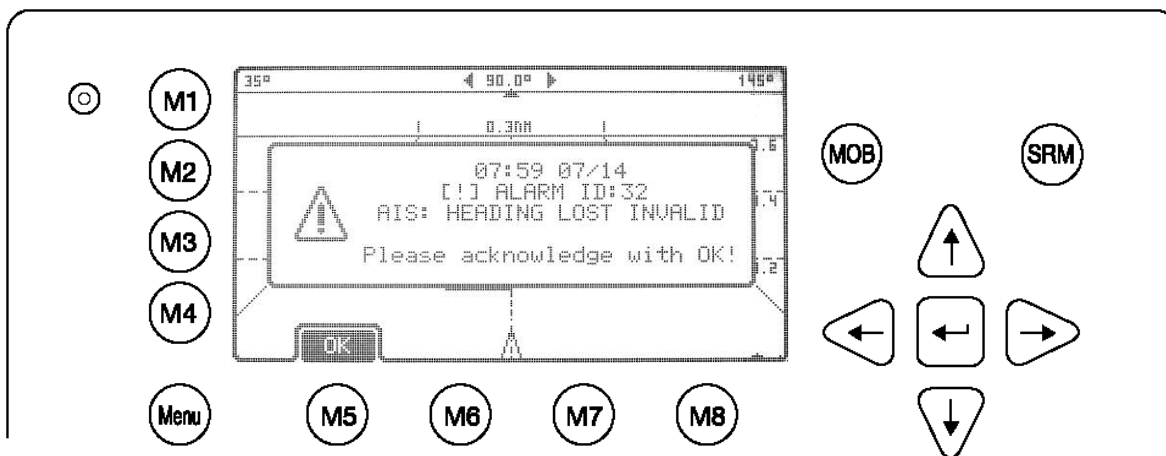

Pressing [M5] leads to alarm acknowledgement and the closure of the window as well as the alarm icon disappearing. An alarm could occur at every time so the alarm icon can be seen in **every** view (in the big views as well as minimized views and ship details list).

Alarms can be set to be displayed <in the foreground > or <minimized >

→ Refer to chapter 3.6.5 Configuration of the Graphical Display for details

Safety Related Messages

If a SRM is received, it is displayed immediately.

Pressing [M5] acknowledges the SRM and closes the window. [M6] acknowledges the SRM and leads you to the text screen for writing an answer.

By pressing [M8] in the "Broadcast Transmission Successful" screen the system returns to the previous graphical view.

3.6.5 Configuration of the Graphical Display

General

The configuration of the Graphical Display could be accessed over the entry point 8 of the Main Menu.

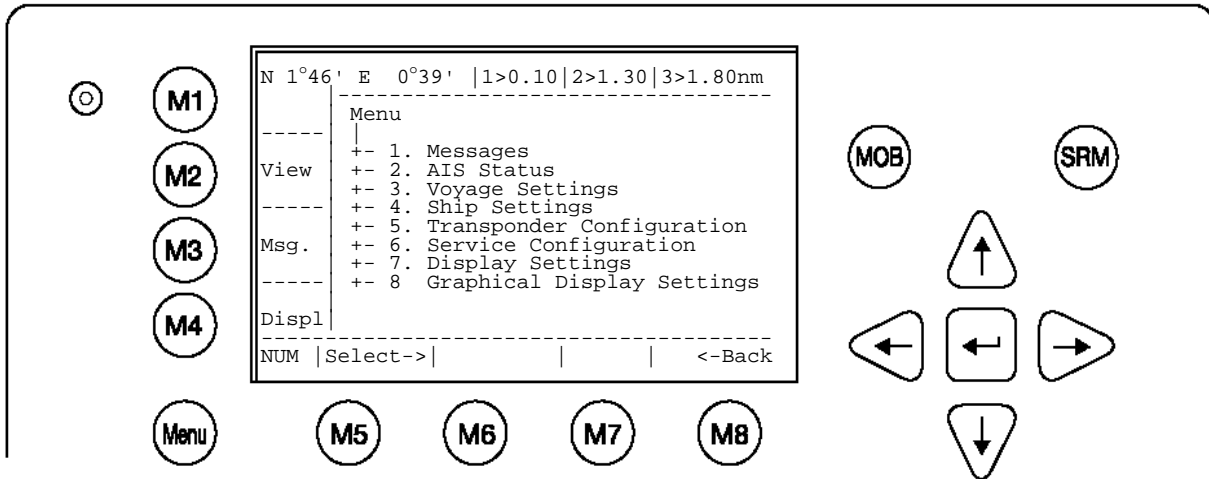

The Configuration Menu allows the user to alter the parameters of the Graphical Display.

Accessing the Configuration Settings:

The Configuration Menu is User Password protected.

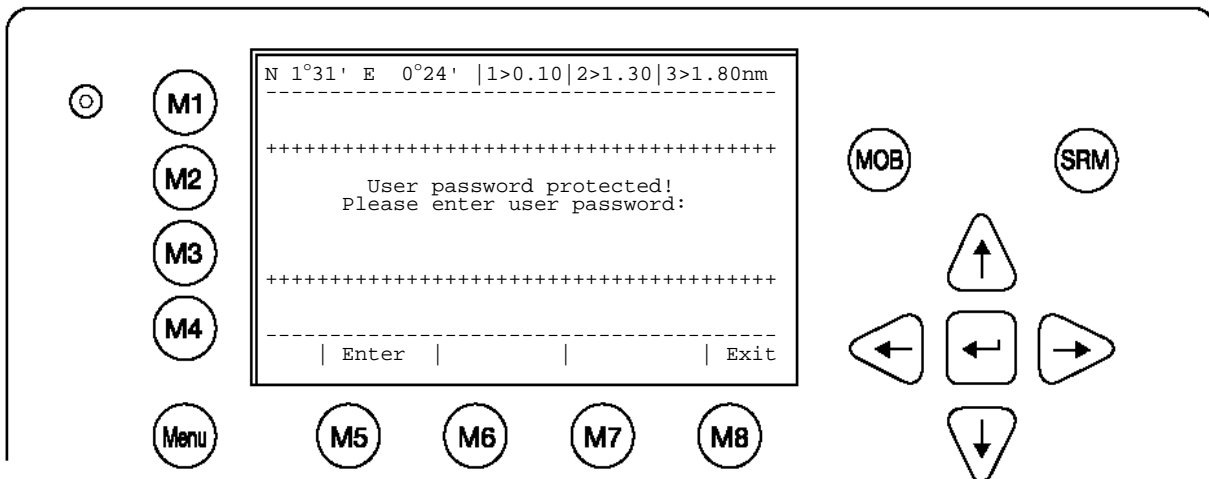

Inside the Graphical Display Setting you can choose out of 3 different Submenus.

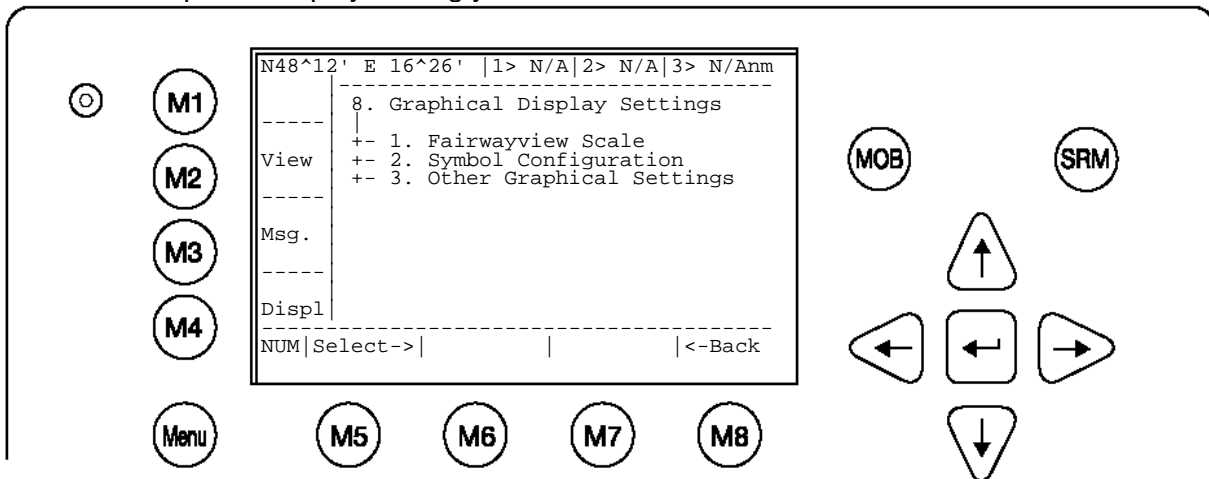

Sub-Menu	Content
Fairway View Scale	Settings of the Geometry and Scale of the Fairway View
Symbol Configuration	Symbol settings of the Fairway and Radar View (also the minimized Views)
Other Graphical Settings	AIS-target filter settings; enabling / disabling the Auto Zoom feature; Alarm appearance

Fairway View Scale

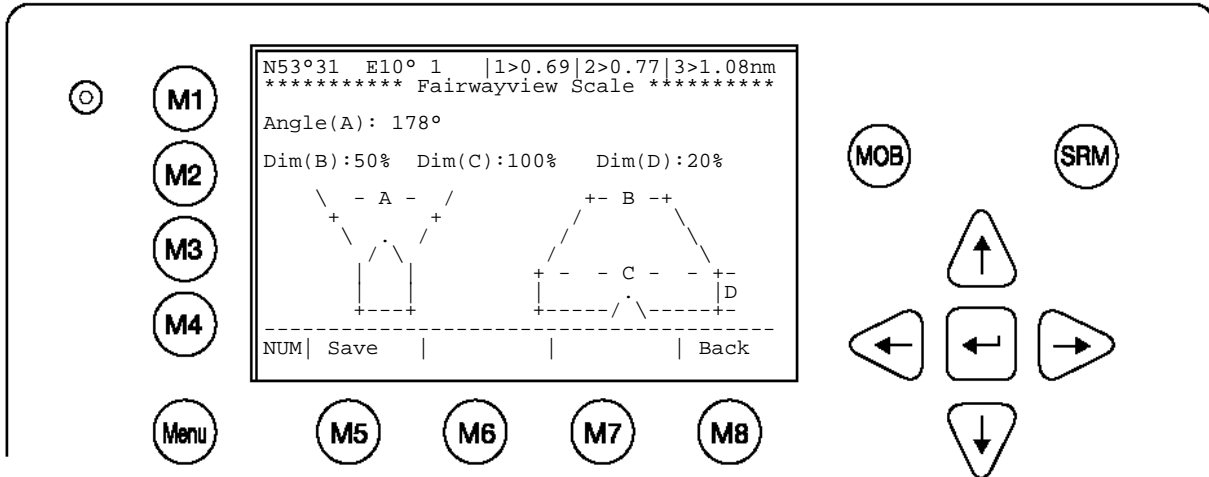

Dynamic Keys: Fairway View Scale					
[M5]	[Save]	Save the settings	[M8]	[Back]	Return to Graphical Display Menu

Parameter description:

Parameter	Description
Angle(A)	The angle α defines the visible sector. Value range: 2° to 178°
Dim(B)	The parameter Dim(B) defines the width of the fairway in percent of the horizontal line. Please ensure that Dim(C) has to be greater or equal to Dim(B). Value range: 10% to 100%
Dim(C)	The parameter Dim(C) defines the width of the fairway in percent of the „Zero-line“ (the horizontal line of the own ship position). If you want to choose a width greater than the visible “Zero-line” you have to enter here 100%, additionally the parameter Dim(D) has to be set to a value greater than zero. Value range: 10% to 100%
Dim(D)	The parameter Dim(D) defines the height of the horizontal guidance lines in percent of the display resolution (pixel). If you want to choose a width greater than the visible “Zero-line” (refer to the horizontal guidance lines f’2) you have to enter the value 0%, additionally the parameter Dim(C) has to be set to 100% (your parameters will pass an internal value check while entering). Value range: 10% to 70%

NOTE: The Fairway View is a “non linear View”.

The following drawing illustrates the parameters from the Fairway View Scale Menu and additionally presents the transformation process from the Radar View to the Fairway View.

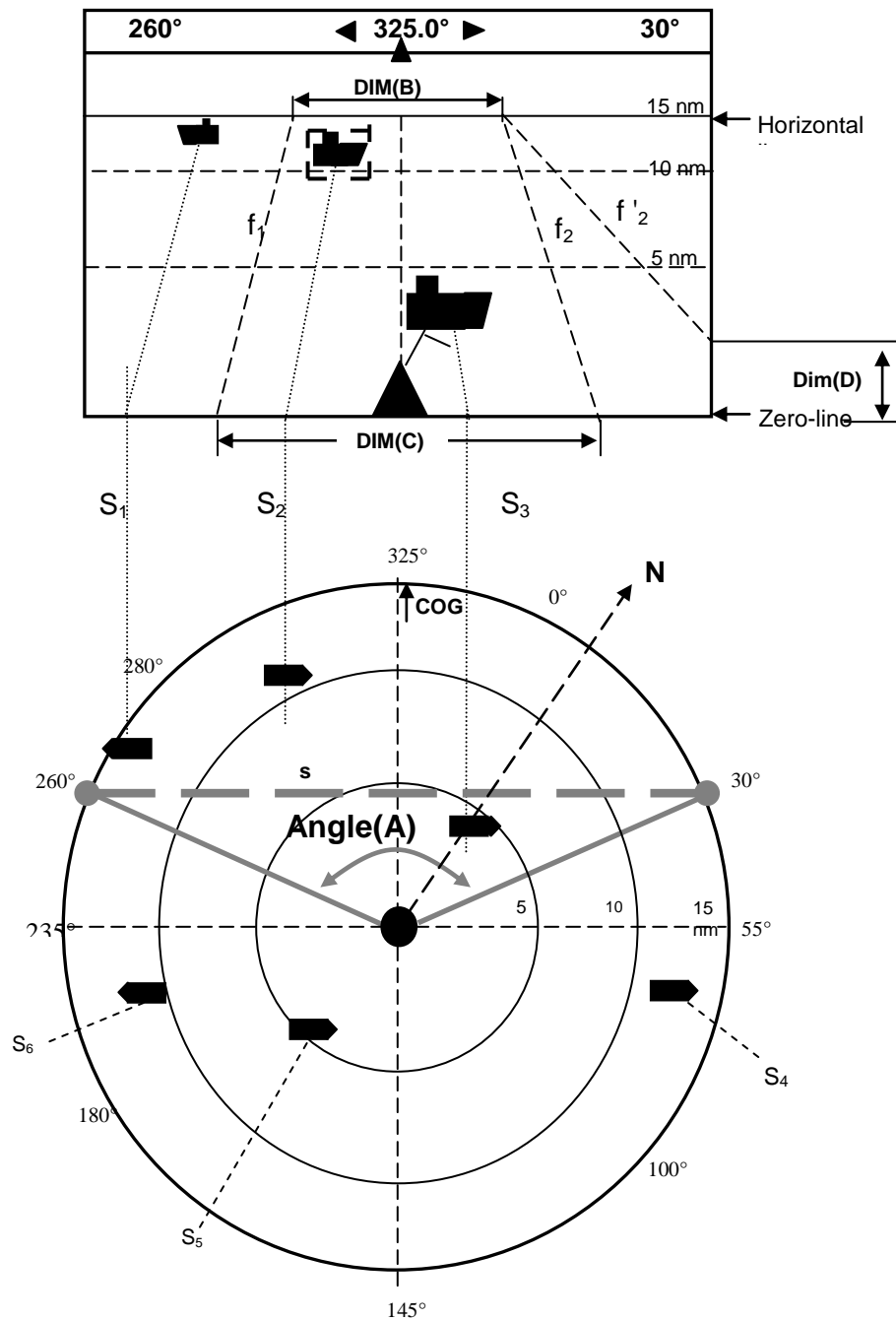

Symbols Configuration

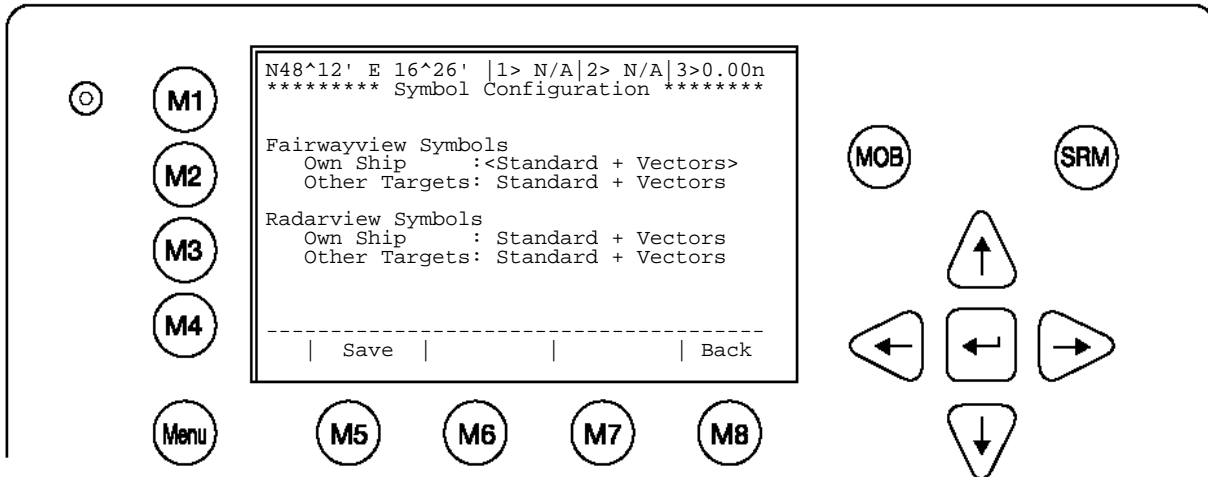

Dynamic Keys: Fairway View Symbols

[M5]	[Save]	Save the settings	[M8]	[Back]	Return to Graphical Display Menu
------	--------	-------------------	------	--------	----------------------------------

The symbols for the own ship and for other targets could be selected individually. Following symbols are available:

Parameter	Symbol
Standard	
Standard + Vectors	
Standard Solid	
Standard Solid + Vectors	
Solid	
Reduced (3x3)	
3D	Samples:

NOTE: Other Symbols (i.e.: for a Base Station) are fixed

Other Settings

Inside this menu it is possible to adjust the graphical view to your demand. The available functions cover the topics:

- AIS-target filter settings
- Enabling / disabling the Auto Zoom feature with max. number of ships
- Alarm appearance

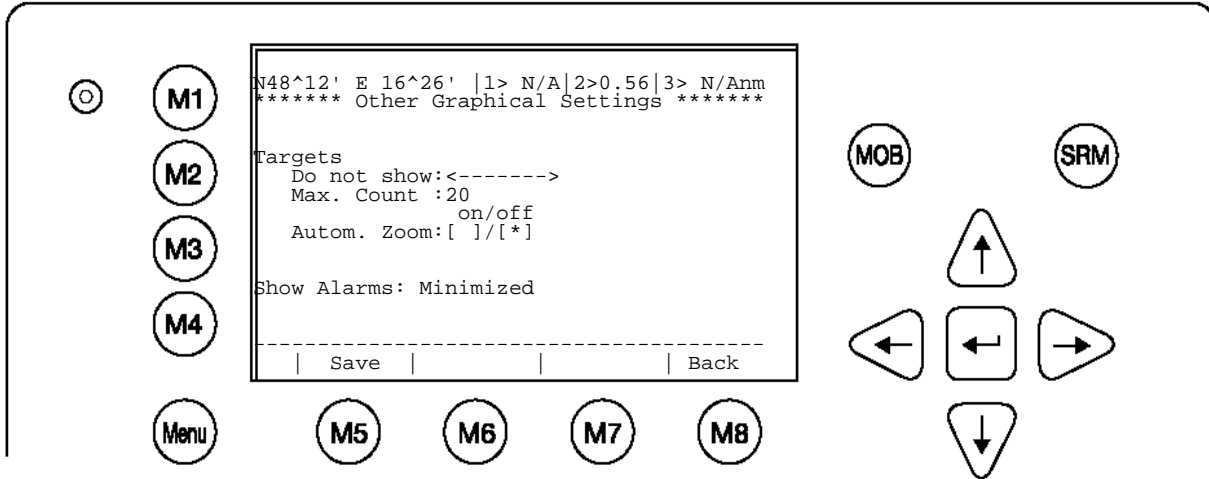

Dynamic Keys: Other Settings					
[M5]	[Save]	Save the settings	[M8]	[Back]	Return to Graphical Display Menu

Targets Filter

This switch [M1] provides a filter for Class A or Class B targets. Targets falling in one of these categories will not be displayed. An icon right to the M1 button indicates which filter is active. Pressing the [M1] button in one of the graphical views will let you toggle this filter online.

Max Count

Sets the maximum number of displayed targets. For example a max Count of 20 displays 20 closest targets.

Auto Zoom

Is set to on, a zoom level is set automatically that the targets fit best into the display. If during Auto Zoom the zoom level is changed manually, the Auto Zoom functionality is interrupted for 30 minutes. Then after this time period, Auto Zoom is active again.

For Example: If you set Max Count to 20 and activate Auto Zoom, then the zoom level will be fitted to show these 20 targets.

Show Alarms:

- Minimized
- In the foreground

The Minimized option shows an icon beside the M3 button if one appears. The In the foreground option displays the alarm immediately.

Save

On all of the described options inside the Configuration of the Graphical User Interface you could save your settings by pressing the [M2] Button.

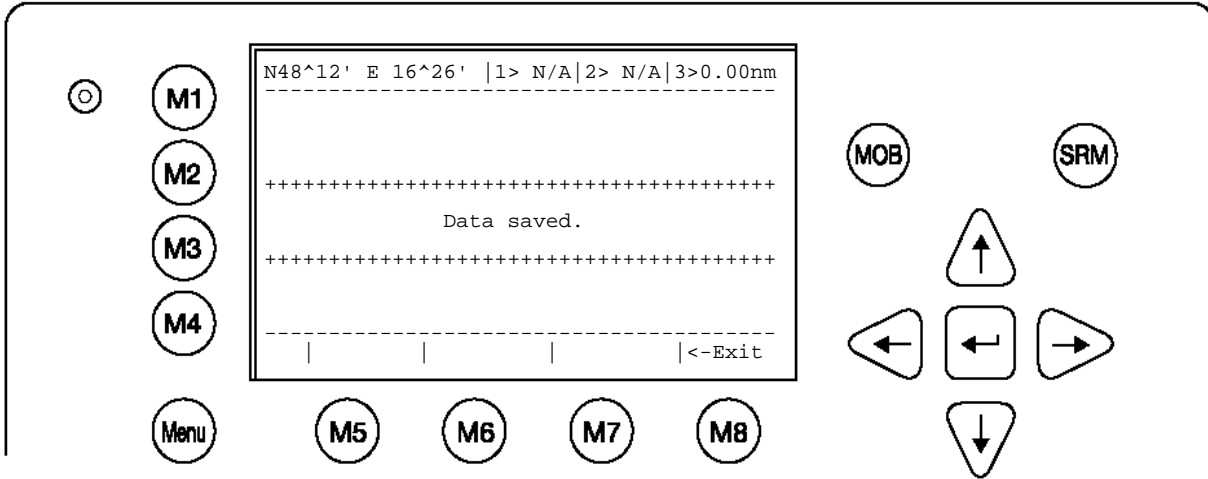

Dynamic Keys: Other Settings					
[M5]	[Save]	Save the settings	[M8]	[Back]	Return to Graphical Display Menu

4 Safety Functions

The NAUTICAST™ is fitted with Safety Keys, which allow the user to automatically send urgent messages without the necessity of navigating the Menus.

The SRM Button sends out Broadcast Safety Related Messages to all ships in the Vessel Listing. The MOB Button sends out precise position of incident to Addressed Vessels, therefore allowing the message to be sent to a vessel closest to accident location.

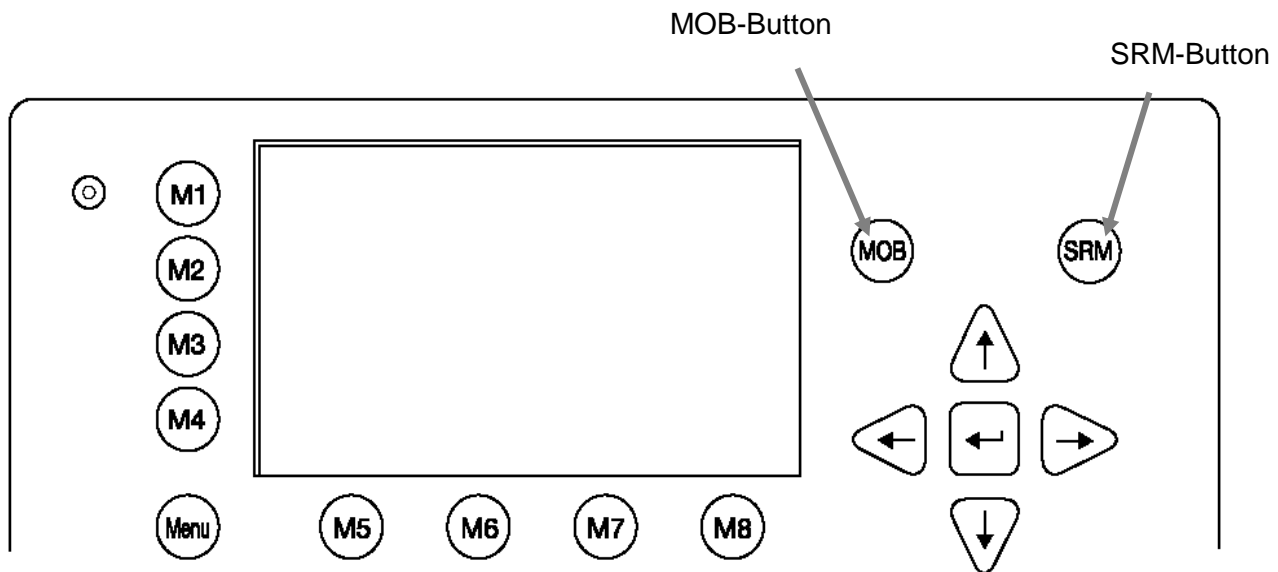

4.1 MOB Person over Board

By pressing the MOB button the current navigation position of own vessel and time of incident is automatically saved. The MOB message containing the distress information "Person Over Board" is automatically prepared for transmission as an Addressed or Broadcast Safety Related Message.

By pressing the [Broadcast] button, the MOB Message is automatically sent to all vessels within receiving range. By activating the [Send] button, an individual vessel can be chosen as recipient of the MOB Message.

The MOB screen shows the 5 closest vessels within receiving range as in some cases it may be helpful to send an individual message to a specific vessel, i.e. to a vessel which, is located closest to own ship or the accident area.

The > at the end of the Vessel Listing indicates, that further Vessels are listed and can be scrolled using the [Left] or [Right] buttons.

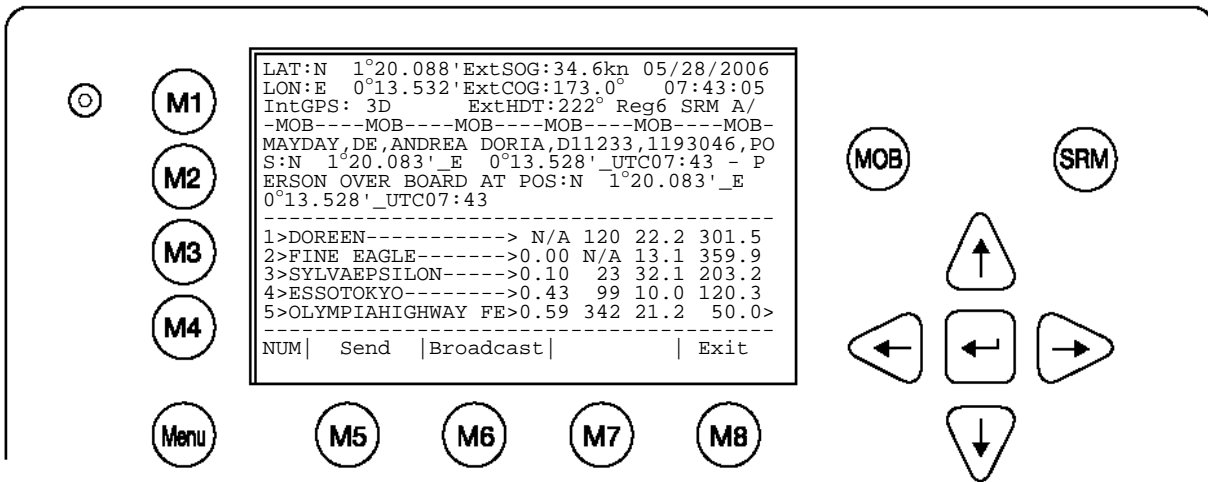

Dynamic Keys: Write Addressed SRM					
[M5]	[Send]	Send an Addressed MOB Message	[M8]	[Exit]	Return to Vessel Listing
[M6]	[Broadcast]	Send a Broadcast MOB Message			

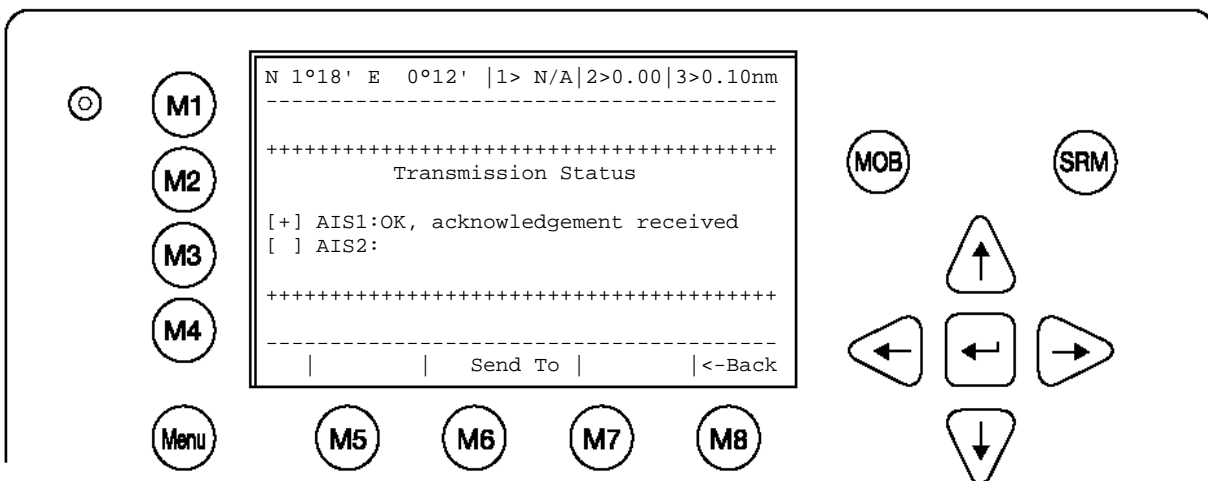

4.2 Activating the SRM Safety Related Message Button

The desired Distress Message Text can be selected by pressing the appropriate number on the keyboard. By pressing the [Exit] button, it is possible to escape from this screen without sending the SRM Message.

NOTE: If no Message Subject is selected, the message is automatically sent as an undesignated distress call.

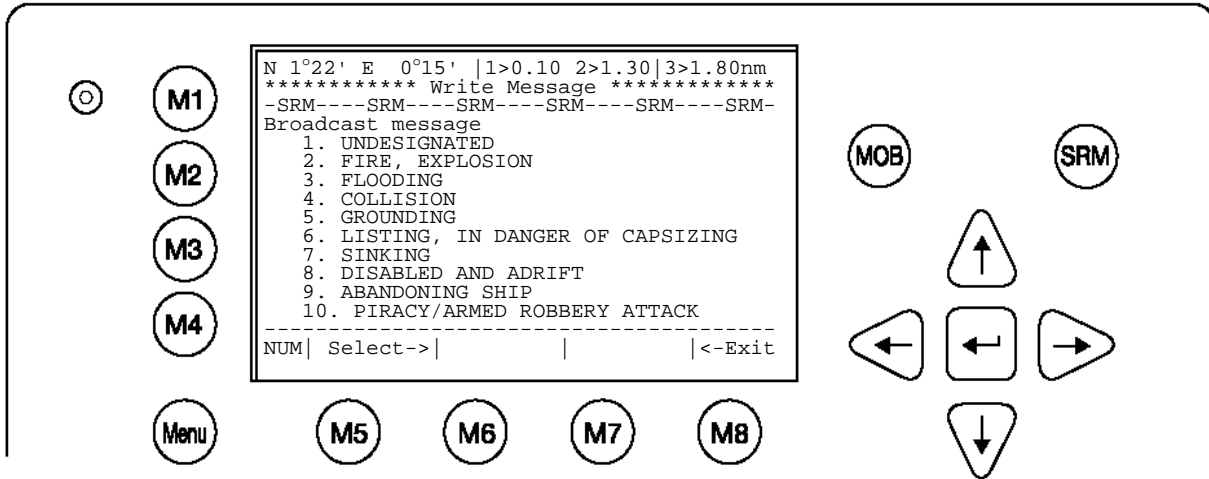

Dynamic Keys: SRM Broadcast Message				
[M5]	[Select]	Confirm Message Selection	[Enter]	Confirm Message Selection
[M8]	[Exit]	Return to Vessel Listing		

Sending an SRM Message:

Upon selection of a message, this screen shows the emergency information, which will be sent and should be checked before transmission. To confirm message transmission to all vessels within range it is necessary to activate either the [Send] or [SRM] button. The [Back] button takes the user back to the Message Selection Menu without sending the message.

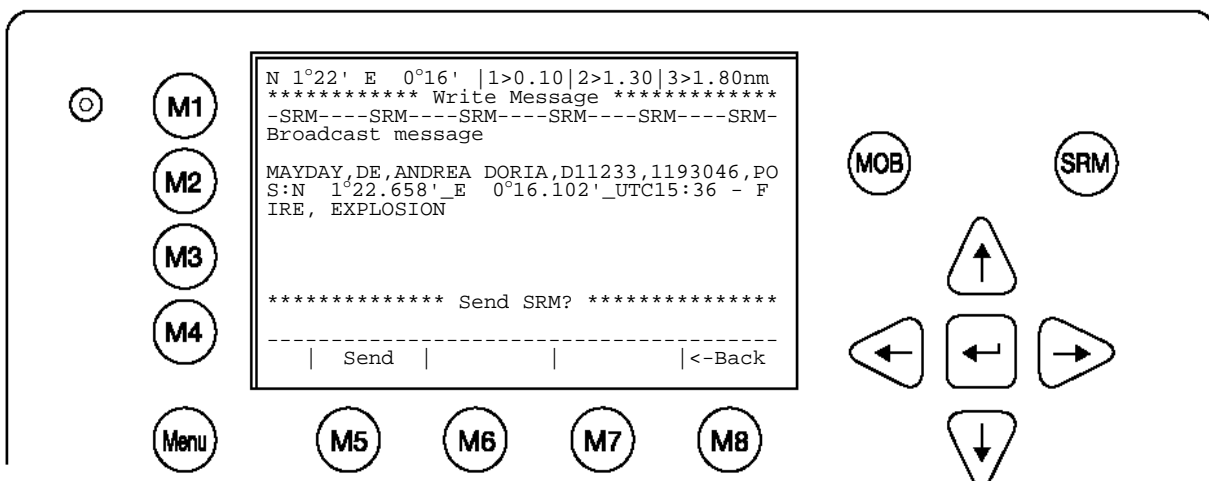

Dynamic Keys: Send SRM Message					
[M5]	[Send]	Send selected SRM Message	[M8]	[Back]	Return to SRM Message Selection

Confirmation of sent SRM:

Upon sending the SRM to all vessels the Broadcast Transmission Status is shown. The Broadcast Transmission Status Screen shows confirmation of sent message and allows the user to return to the Vessel Listing for further messaging to individual vessels.

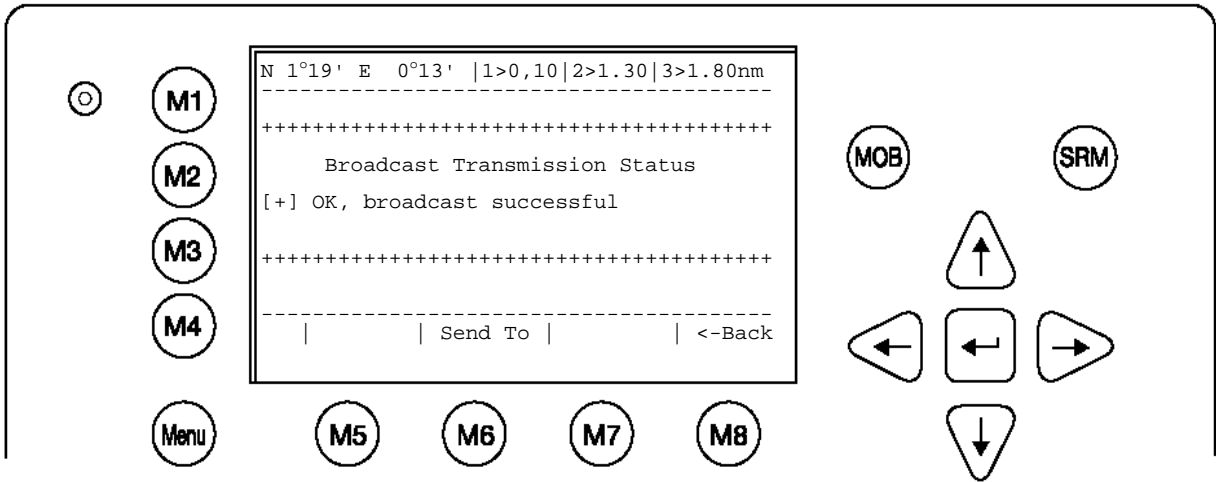

Dynamic Keys: Confirmation of Broadcast SRM					
[M6]	[SendTo]	Return to Vessel Listing for further Messaging	[M8]	[Back]	Return to SRM Message View

After pressing [SendTo] from the previous screen, the user is taken back to the Vessel Listing for the option of writing further addressed messages.

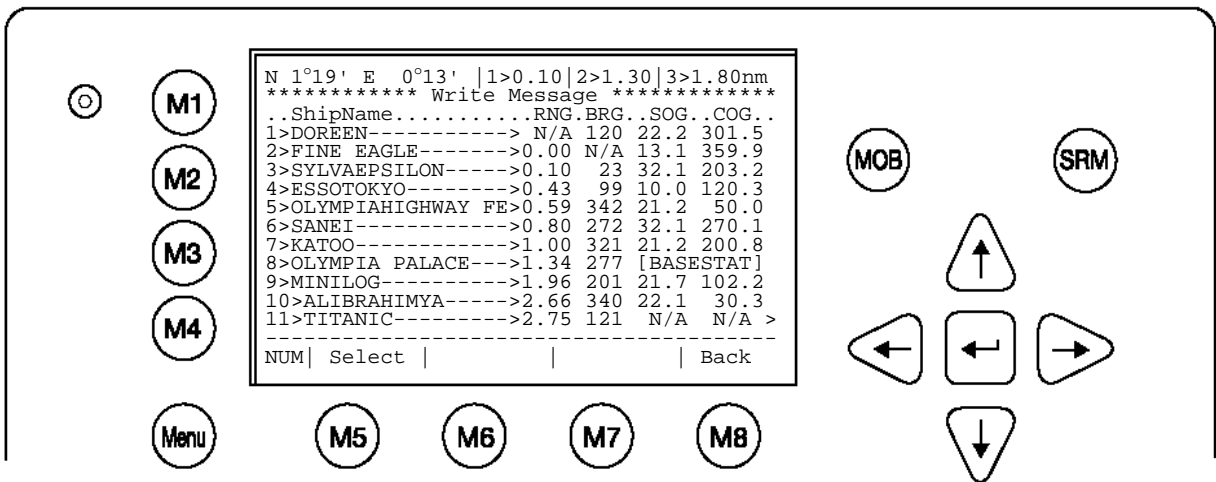

Dynamic Keys: Send SRM to Addressed Vessel					
[M5]	[Select]	Select Vessel for Messaging	[M8]	[Back]	Return to Submenu Messages

NOTE: The SRM message transmission is automatically repeated every 180 seconds until the [Stop] button has been pressed.

Each SRM Message that is sent out every 180 seconds contains updated navigation information of own vessel position and actual time.

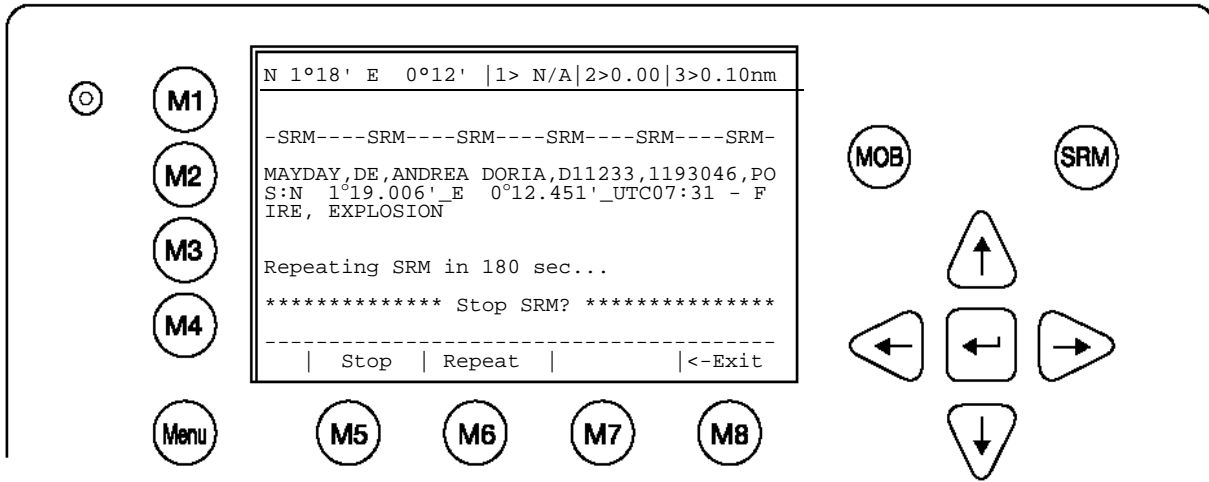

Dynamic Keys: SRM Message View					
[M5]	[Stop]	Discontinue SRM Message Transmission in 180 secs.	[M8]	[Exit]	Return to Vessel Listing
[M6]	[Repeat]	Repeat SRM Message Transmission immediately			

Sending a further SRM to an Addressed Vessel:

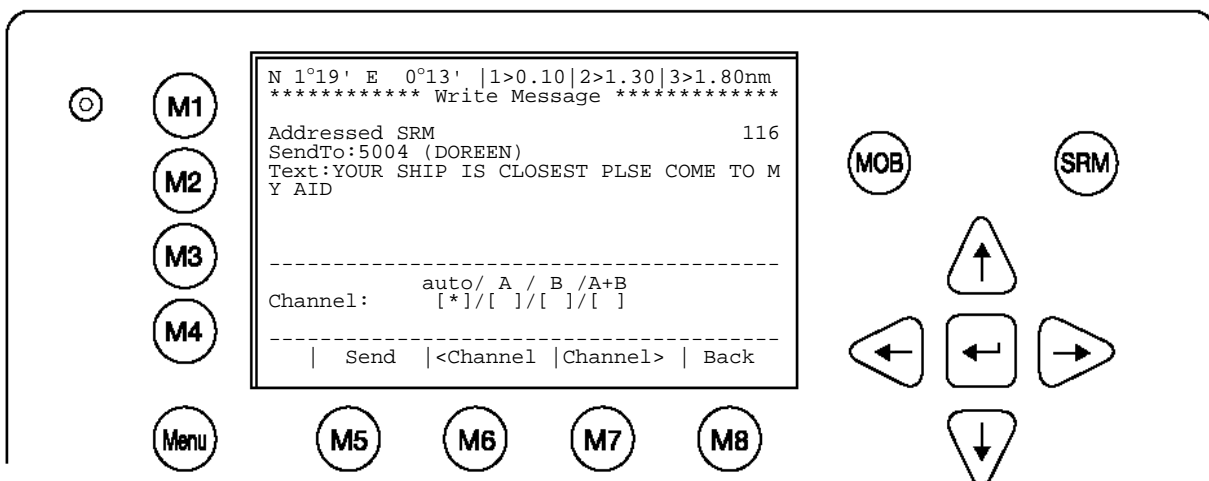

Dynamic Keys: Write Addressed SRM					
[M5]	[Send]	Send Message	[M8]	[Back]	Return to Vessel Listing
[M6]	[Channel]	Select Transmission Channel	[M7]	[Channel]	Select Transmission Channel

5 Troubleshooting

5.1 Reading and understanding Alarms:

The NAUTICAST™ differentiates between Alarm and TXT messages. An Alarm informs the user about major system malfunctions and failings in the connected sensors.

The Alarm Status informs the user about all active Alarms. The Alarm will be disabled and deleted from the Alarm Status, as soon as the displayed problem has been rectified.

The TXT status displays additional sensor information and the UTC clock status. See tables (page 41) for Alarm and TXT Messages.

Select “AIS Status” with cursor button [Up] & [Down] or press No. 2 on the keyboard.

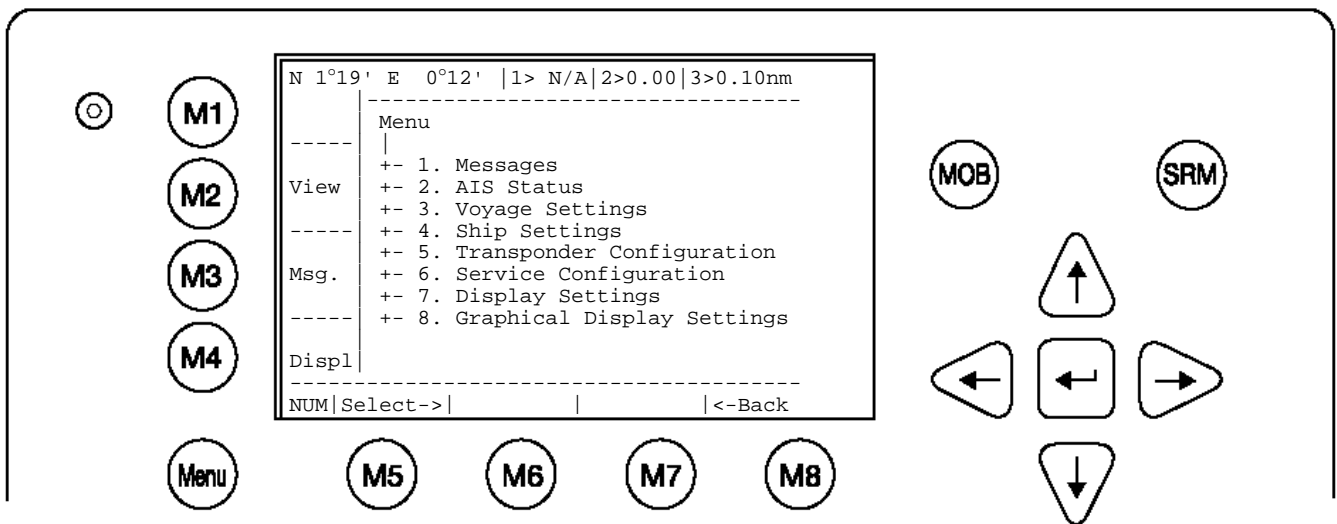

Select “Alarm Status” or “TXT Status” with cursor button [Up] & [Down] or press No. 4 or 5 on the keyboard.

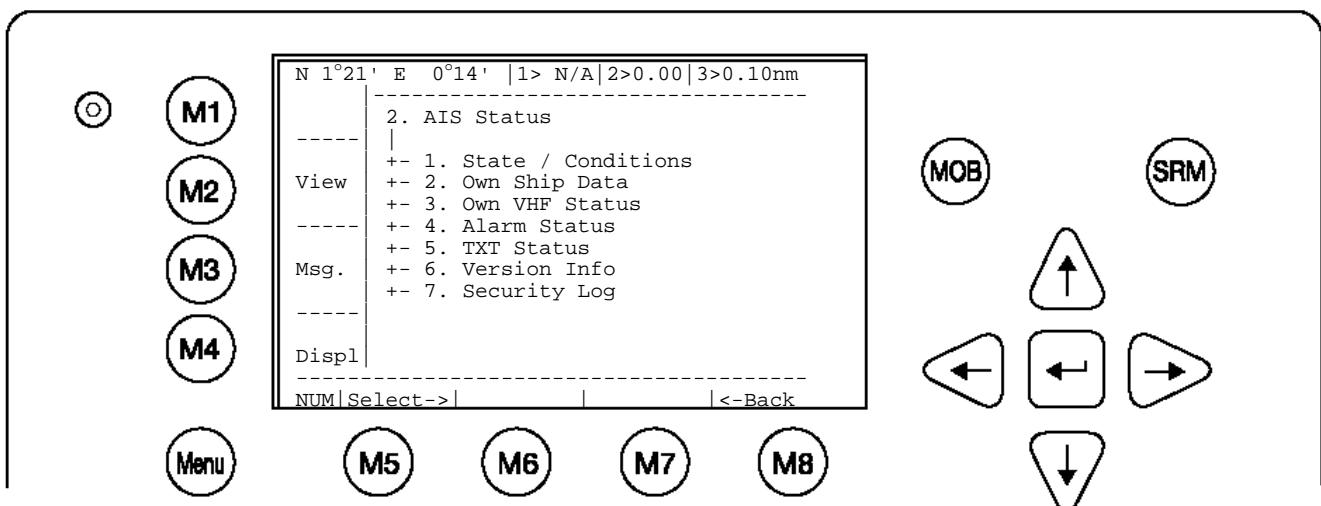

5.2 Alarm Codes

ID	Description Text	Cause/Source	System Reaction / Remedy
01	AIS: Tx malfunction	VHF Antenna, cabling	Reaction: The transponder unit stops transmission. If Alarm ID 01 and ID 02 are simultaneously displayed, then a major antenna problem has arisen. Remedy: Check if the antenna is AIS compatible (156-162 MHz) and if the antenna cabling has a short circuit or is missing any contacts at the connectors. If the ID 01 is displayed as a stand alone message, then the unit requires replacing.
02	AIS: Antenna VSWR exceeds limit (VSWR - Voltage Standing Wave Ratio)	VHF antenna, installation	Reaction: The transponder unit continues transmission. Remedy: Check the antenna and the antenna cabling (RG214 / 50 Ohm cable required).
03	AIS: Rx channel 1 malfunction	Internal error	Reaction: The transponder unit stops transmission on the affected channel, Remedy; If this alarm reoccurs regularly, then the transponder unit requires replacing.
04	AIS: Rx channel 2 malfunction		
05	AIS: Rx channel 70 malfunction		
06	AIS: General failure	Internal error	Reaction: The transponder unit stops transmission. Remedy; The transponder unit requires replacing.
25	AIS; External EPFS lost (EPFS = Electronic Position Fixing System such as GPS)	No valid data on Ch1, Ch2 or Ch3 is available	Reaction: The transponder unit continues operation using the position data of the internal GPS. If there is no valid position data available from the internal GPS, error 026 is additionally displayed. Remedy: Id 25 indicates that the sentences GLL, GNS, GGA, RMC cannot be received. Check the sensor and the cabling; check if the system that delivers the data is working. Check the baud rate settings of the sensor inputs. AIS requires the protocol NMEA 0183 V3.0! Normally Inland Vessels have no external EPFS → no action required!
26	AIS: No sensor position in use	No valid position from internal GPS or external position sensor	Reaction: The transponder unit continues operation. Remedy: Check the sensor cabling and the antenna of the internal GPS sensor.
29	AIS: No valid SOG information	No valid data from external speed sensor or internal GPS	Reaction: The transponder unit continues operation and displays SOG: N/A Remedy: The sentences VBW, VTG, RMC cannot be received. Check the sensor and the cabling; check if the system that delivers the data is working. Check the baud rate settings of the sensor inputs. AIS requires the protocol NMEA 0183 V3.0!
30	AIS: No valid COG Information	No valid data from external sensor or internal GPS	Reaction: The transponder unit continues operation and displays COG: N/A Remedy: The sentences VBW, VTG, RMC cannot be received. Check the sensor and the cabling, check if the system that delivers the data is working. Check the baud rate settings of the sensor inputs. AIS requires the protocol NMEA 0183 V3.0!
32	AIS: Heading lost/invalid	No valid data from external sensor (Gyrocompass)	Reaction: The transponder unit continues operation Remedy: The sentence for HDT cannot be received. Check the sensor and the cabling, check if the system that delivers the data is working. Check the baud rate settings of the sensor inputs. Mention AIS accepts true heading only (no magnetic). Normally Inland Vessels have no Gyrocompass → no action required!
35	AIS: No valid ROT Information	No ROT indicator is used. No valid data from external sensor	Reaction: The transponder unit continues operation Remedy: The sentence for ROT cannot be received. If a Rate Of Turn indicator is not in use, then it suffices to just acknowledge the alarm. The Alarm Status will store the information that no ROT sensor is available. Otherwise, check the sensor and the cabling. Check if the system that delivers the data is working. Check the baud rate settings of the sensor inputs. The AIS requires the protocol NMEA 0183 V3.0! Normally Inland Vessels have no ROT indicator → no action required!
53	AIS: BATTERY SOON LOW	Battery is soon out of capacity	Reaction: Own ship data is lost after powering on/off the system. Remedy: consider to contact Technical Support for additional help
55	AIS: PRESS ENTER TO EXIT 1W/AUTO TX MODE	Conditions for enabling 1 Watt TX power are not valid	Reaction: Conditions for enabling 1 Watt TX power are not valid. This means that: <ul style="list-style-type: none"> • the speed is >3kn and / or • the navigational status is NOT moored / at anchor and / or • the ship type is NOT "Tanker" Remedy: <ul style="list-style-type: none"> • Check the conditions (SOG, Navstat, Shiptype) • if GPS is valid (a invalid GPS causes also this alarm)
56	AIS: ENTER MMSI NUMBER	No valid MMSI entered.	Reaction: During the initial boot or after "factory settings" the user is asked to enter a valid MMSI. As long as this is not done, the system does not transmit. Remedy: Enter a valid MMSI

5.3 Text Messages

ID	Description Text	Cause/Source	Reaction of the System / Remedy
07	AIS: UTC clock lost	Internal GPS	Reaction: the transponder unit continues operation using indirect or semaphore synchronisation Remedy: Check GPS Antenna for AIS.
21	AIS: external DGNSS in use	Information	Reaction: Positioning is fully operational Remedy: no action required
22	AIS: external GNSS in use	Information	Reaction: The transponder unit continues operation using the position data from a GNSS receiver Remedy: no action required
23	AIS: internal DGNSS in use (beacon) 023	Information	Reaction: The transponder unit uses position data from the internal source. The internal GNSS receiver is capable of processing DGNSS corrections. Remedy: no action required
24	AIS: internal DGNSS in use (message 17)		
25	AIS: internal GNSS in use	Information additional to Alarm ID 25	Reaction: The transponder unit continues operation using the position data from the internal GPS. Remedy: Check the sensor and the cabling; Check if the system that delivers the data is working; Check the baud rate settings of the sensor input
27	AIS: external SOG/COG in use	Information	Reaction: COG/SOG is in full operation Remedy: no action required
28	AIS: internal SOG/COG in use	Information additional to Alarm ID 29 or ID 30	Reaction: The transponder unit continues operation using the data from the internal GPS. Remedy: Check the sensor and the cabling; Check if the system that delivers the data is working; Check the baud rate settings of the sensor inputs
31	AIS: Heading valid	Information	Reaction: Heading is in full operation Remedy: no action required
33	AIS: Rate of Turn Indicator in use	Information	Reaction: A Rate Of Turn indicator is connected and in full operation Remedy: no action required
34	AIS: Other ROT source in use	Information	Reaction: The transponder unit is operating with ROT data rather than with TIROT data - therefore the AIS only differs between + 127 (turning right at 720 degrees per minute or higher) and - 127 (turning left at 720 degrees per minute or higher)

5.4 Restarting the NAUTICAST™

The NAUTICAST™ can be restarted during operation by pressing the keys “Shift” + “Fn” + “Del” simultaneously. It could take up to 6 minutes to receive all information from other ships again because of their reporting interval.

6 Contact and Support Information

Contact your local dealer for NAUTICAST™ support.
Please see our ACR Website for Service Listing.

ACR Electronics Europe GmbH
Handelskai 388 / Top 632
A-1020 Vienna, Austria
Tel: +43 (1) 5 237 237 - 0
Fax: +43 (1) 5 237 237 - 150
Email: Technical.Support@acr-europe.com
Web: www.acr-europe.com

ACR Electronics
Customer Service
5757 Ravenswood Road
Fort Lauderdale, FL 33312, U.S.A.
Tel.: +1 (954) 981-3333
Fax: +1 (954) 983-5087
Email: info@acrelectronics.com
Web: www.acrelectronics.com

7 Appendix

7.1 Explanation of commonly used Abbreviations

Abbreviation	Full Text
A/B (A+B)	AIS Channel 1 / AIS Channel 2
ACK	Acknowledgement
AddrChM	Addressed Channel Management
AIS	Automatic Identification System
AIS_ChAs	AIS Channel Assignment Sentence
ALR	Alarm
AS	Assigned
ATIS	Automatic Transmitter Identification
AU	Autonomous
BcastChM	Broadcast Channel Management
BRG	Vessel True Bearing
COG	Course Over Ground
DAC	Designated Area Code
Dest	Destination
DGNSS	Differential Global Navigation
Dist	Distance
DSC	Digital Selective Calling
DTE	Data Terminal Equipment
ECDIS	Electronic Chart Display
ENI	European Vessel Identification
EPFD	Electronic Position Fixing Device
EPFS	Electronic Position Fixing System
ERI	Ship Types – add. types to IMO high
ESN	European Ship Number
ETA	Estimated Arrival Time
ExtGPS	External Global Positioning System
ExtHDT	External Heading True
ExtSOG	External Speed Over Ground
GNSS	Global Navigation Satellite Service
GPS	Global Positioning System
IMO No	International Maritime Association
IN	Interrogation/Polled Mode
ExtCOG	External Course Over Ground
IntGPS	Internal Global Positioning System
LAT	Latitude
LON	Longitude
LRI	Long Range Interrogation
MMSI	Maritime Mobile Service Identity
MOB	Man Over Board
Mod	Mode
NavStat	Navigational Status
Nm	Nautic Miles
OpManual	Operator Manual
PoB	Persons on Board
Pos	Position
PosAcc	Position Accuracy
Reg	Region
RNG	Rating
Rng	Vessel Range

ROT	Rate of Turn
RxA	Receiving AIS Channel
RxB	Broadcasting AIS Channel
RXVe	Received vessels
SOG	Speed Over Ground
SRM	Safety Related Message
Syn	synchronization
TrZone	Transitional Zone
TxA	Transmitting on Channel A
TxB	Transmitting on Channel B
UTC	Universal Time Coordinated
VHF	Very High Frequency

7.2 ERI ship types

This table is used to automatically convert the selected UN ship types, which are used in Inland message 10, to the IMO types which are used in IMO message 5.

Code	U	Ship Name	Msg 5 (1-99)		Ship Type - SOLAS	
			Dig1	Dig2	Type (first digit)	Cargo (second digit)
8000	No	Vessel, type unknown	9	9	Other types of Ship	No additional information
8010	V	Motor freighter	7	9	Cargo Ships	No additional information
8020	V	Motor tanker	8	9	Tanker	No additional information
8021	V	Motor tanker, liquid cargo, type N	8	0	Tanker	All ships of this type
8022	V	Motor tanker, liquid cargo, type C	8	0	Tanker	All ships of this type
8023	V	Motor tanker, dry cargo as if liquid (e.g. cement)	8	9	Tanker	No additional information
8030	V	Container vessel	7	9	Cargo Ships	No additional information
8040	V	Gas tanker	8	0	Tanker	All ships of this type
8050	C	Motor freighter, tug	7	9		No additional information
8060	C	Motor tanker, tug	8	9	Tanker	No additional information
8070	C	Motor freighter with one or more ships alongside	7	9	Cargo Ships	No additional information
8080	C	Motor freighter with tanker	8	9	Tanker	No additional information
8090	C	Motor freighter pushing one or more freighters	7	9	Cargo Ships	No additional information
8100	C	Motor freighter pushing at least one tank-ship	8	9	Tanker	No additional information
8110	No	Tug, freighter	7	9	Cargo Ships	No additional information
8120	No	Tug, tanker	8	9	Tanker	No additional information
8130	C	Tug freighter, coupled	3	1	Vessel	Towing
8140	C	Tug, freighter/tanker, coupled	3	1	Vessel	Towing
8150	V	Freightbarge	9	9	Other types of Ship	No additional information
8160	V	Tankbarge	9	9	Other types of Ship	No additional information
8161	V	Tankbarge, liquid cargo, type N	9	0	Other types of Ship	All ships of this type
8162	V	Tankbarge, liquid cargo, type C	9	0	Other types of Ship	All ships of this type
8163	V	Tankbarge, dry cargo as if liquid (e.g. cement)	9	9	Other types of Ship	No additional information
8170	V	Freightbarge with containers	8	9	Tanker	No additional information
8180	V	Tankbarge, gas	9	0	Other types of Ship	All ships of this type
8210	C	Pushtow, one cargo barge	7	9	Cargo Ships	No additional information
8220	C	Pushtow, two cargo barges	7	9	Cargo Ships	No additional information

code	U	ship name	Msg 5 (1-99)		Ship Type - SOLAS	
			dig1	dig2	Type (first digit)	Cargo (Second digit)
8230	C	Pushtow, three cargo barges	7	9	Cargo Ships	No additional information
8240	C	Pushtow, four cargo barges	7	9	Cargo Ships	No additional information
8250	C	Pushtow, five cargo barges	7	9	Cargo Ships	No additional information
8260	C	Pushtow, six cargo barges	7	9	Cargo Ships	No additional information
8270	C	Pushtow, seven cargo barges	7	9	Cargo Ships	No additional information
8280	C	Pushtow, eighth cargo barges	7	9	Cargo Ships	No additional information
8290	C	Pushtow, nine or more barges	7	9	Cargo Ships	No additional information
8310	C	Pushtow, one tank/gas barge	8	0	Tanker	All ships of this type
8320	C	Pushtow, two barges at least one tanker or gas barge	8	0	Tanker	All ships of this type
8330	C	Pushtow, three barges at least one tanker or gas barge	8	0	Tanker	All ships of this type
8340	C	Pushtow, four barges at least one tanker or gas barge	8	0	Tanker	All ships of this type
8350	C	Pushtow, five barges at least one tanker or gas barge	8	0	Tanker	All ships of this type
8360	C	Pushtow, six barges at least one tanker or gas barge	8	0	Tanker	All ships of this type
8370	C	Pushtow, seven barges at least one tanker or gas barge	8	0	Tanker	All ships of this type
8380	C	Pushtow, eight barges at least one tanker or gas barge	8	0	Tanker	All ships of this type
8390	C	Pushtow, nine or more barges at least one tanker or gas barge	8	0	Tanker	All ships of this type
8400	V	Tug, single	5	2	Tugs	-
8410	No	Tug, one or more tows	3	1	Vessel	Towing
8420	C	Tug, assisting a vessel or linked combination	3	1	Vessel	Towing
8430	V	Pushboat, single	9	9	Other types of Ship	No additional information
8440	V	Passenger ship, ferry, cruise ship, red cross ship	6	9	Passenger Sips	No additional information
8441	V	Ferry	6	9	Passenger Sips	No additional information
8442	V	Red cross ship	5	8	Medical transports	-
8443	V	Cruise ship	6	9	Passenger Sips	No additional information
8444	V	Passenger ship without accomodation	6	9	Passenger Sips	No additional information
8450	V	Service vessel, police patrol, port service	9	9	Other types of Ship	No additional information

code	U	ship name	Msg 5 (1-99)		Ship Type - SOLAS	
			dig1	dig2	Type (first digit)	Cargo (Second digit)
8460	V	Vessel, work maintenance craft, floating derrick, cable-ship, buoy-ship, dredge	3	3	Vessel	Engaged in dredging or underwater operations
8470	C	Object, towed, not otherwise specified	9	9	Other types of Ship	No additional information
8480	V	Fishing boat	3	0	Vessel	All ships of this type
8490	V	Bunkership	9	9	Other types of Ship	No additional information
8500	V	Barge, tanker, chemical	8	0	Tanker	All ships of this type
8510	C	Object, not otherwise specified	9	9	Other types of Ship	No additional information
1500	V	General cargo Vessel maritime	7	9	Cargo Ships	No additional information
1510	V	Unit carrier maritime	7	9	Cargo Ships	No additional information
1520	V	Bulk carrier maritime	7	9	Cargo Ships	No additional information
1530	V	Tanker	8	0	Tanker	All ships of this type
1540	V	Liquified gas tanker	8	0	Tanker	All ships of this type
1850	V	Pleasure craft, longer than 20 metres	3	7	Vessel	Pleasure Craft
1900	V	Fast ship	4	9	HSC – high speed craft	No additional information
1910	V	Hydrofoil	4	9	HSC – high speed craft	No additional information
1920	V	Catamaran fast	4	9	HSC – high speed craft	No additional information

7.3 Password Settings

This AIS transponder has two levels of password-protected security. The “User Password” gives access to user-level privileges and the “Service Password” gives access to administrative privileges. The default password from the factory is mentioned on your AIS display at the protection foil.

Once you have entered the system, please change the default password to your own passwords, for both levels of access. Use different passwords for the different security levels. Your passwords must meet the following criteria:

- Minimum of six (6) characters , maximum of eight (8) characters
- Letters must be in UPPER CASE
- Acceptable characters are the A-Z alphabet and 0- 9 digits
- Password may contain both letters and numbers

After you have changed the password, write it down below.

 **WARNING: It is very important that the Service password not be lost.** Keeping the password in a second location may be wise. Memorizing the password is best. If you lose this password, you cannot make any further configuration changes: Access to the AIS is blocked. Another master key is not available and the unit would have to be returned to the ACR Service centre. This service is not free of charge.

Ship Service Password: <small>(min. 6 - max. 8 chrs. UPPER CASE, A-Z; 0-9)</small>	
Ship User Password: <small>(min. 6 - max. 8 chrs., UPPER CASE, A-Z; 0-9)</small>	
Off ship location of Service password:	<small>(Examples: “Call Ship Security Officer at _____”, “Call the office at _____”, “Mr. Jones’ files at the office”, etc.)</small>



WSV.de

Wasser- und
Schiffahrtsverwaltung
des Bundes

Zulassungsurkunde

Type Approval Certificate

Nr.: R - 4 - 203

Gemäß dem von der Zentralkommission für die Rheinschifffahrt (ZKR) beschlossenen
In accordance with the regulation adopted by the Central Commission for the Navigation on the River Rhine (CCNR)

**Standard Schiffsverfolgung und Aufspürung in der Binnenschifffahrt,
Edition 1.01 vom 10.10.2007**

und den
and the

**Betriebs- und Leistungsanforderungen, Prüfmethode und geforderten
Prüfergebnissen gemäß Test Standard für Inland AIS, Edition 1.0 vom 31.5.2007**

wird das Inland AIS Bordgerät
the Inland AIS equipment

NAUTICAST Inland AIS

des Herstellers
of the manufacturer

ACR Electronics INC, 5757 Ravenswood Road, Fort Lauderdale, FL 33312, USA

bestehend aus
components necessary for operation

ACR NAUTICAST Inland AIS unit;

Part No.: Part No.: 2662; SW Version No.: V2.0.S116.xxxx

Minimum Keyboard and Display; internal

GPS antenna; Part No.: ProCom GPS4 P/N 2612 or equivalent

VHF antenna; Part No.: VH-3200 P/N 2628 or equivalent

als Inland AIS Gerät für die Binnenschifffahrt zugelassen.
has been approved as Inland AIS equipment for Inland Navigation.

Die Zulassung wird dem Antragsteller:
The type approval has been issued for the applicant:

ACR Electronics Europe GmbH, Handelskai 388/Top 632, 1020 Wien, Österreich
erteilt.

Die Zulassungsinhaberin hat jede Änderung dieses Gerätetyps der Fachstelle der WSV für
Verkehrstechniken mitzuteilen.

The manufacturer shall inform Fachstelle der WSV für Verkehrstechniken of any modification to the type tested products.

Fachstelle der WSV für Verkehrstechniken
Im Auftrag / *by order*

(Bober)

Koblenz, den 28.11.2008





Bundesrepublik Deutschland

Federal Republic of Germany

Bundesamt für Seeschifffahrt und Hydrographie

Federal Maritime and Hydrographic Agency



BUNDESAMT FÜR
SEESCHIFFFAHRT
UND
HYDROGRAPHIE

EC TYPE EXAMINATION (MODULE B) CERTIFICATE

This is to certify that:

Bundesamt für Seeschifffahrt und Hydrographie, specified as a "notified body" under the terms of „Schiffssicherheitsgesetz“ of 9. September 1998 (BGBl. I, p. 2860) modified last 08. April 2008 (BGBl. I, p. 706), did undertake the relevant type approval procedures for the equipment identified below which was found to be in compliance with the Navigation requirements of Marine Equipment Directive (MED) 96/98/EC and the last modification by Directive 2009/26/EC.

Manufacturer **ACR Electronics Inc.**
 Address **5757 Ravenswood Road,
FORT LAUDERDALE, FL 33312-6645, USA**

Applicant **ACR Electronics Europe GmbH**
 Address **Handelskai 388 / Top 632, 1020 VIENNA, AUSTRIA**

Annex A.1 Item (No & item designation) **4.32 Universal automatic identification system equipment (AIS)**

Product Name **NAUTICAST™ AIS**

Trade Name(s) **See Page 2 of this certificate**

Specified Standard(s)

IMO Resolution MSC.74(69) Annex 3	IEC 61993-2 Ed.1.0, 2001
ITU-R M.1371-3 (Class A)	IEC 61162-1 Ed.3.0, 2007
ITU-R M.1084-3	IEC 61162-2 Ed.1.0, 1998
ITU-R M.825-3	IEC 60945 Ed.4.0, 2002
	IEC 61108-1 Ed.2.0, 2003

Applied version of Annex A.1 (MED): Directive 2008/67/EC

This certificate remains valid unless cancelled, expired or revoked.

Date of Issue: **2009-07-21**

Issued by: **Bundesamt für Seeschifffahrt und Hydrographie
Bernhard-Nocht-Str. 78, 20359 Hamburg, Germany
Notified body 0735**

Expiry date: **2014-07-20**

Certificate No.: **BSH/4612/4321220/09**

This certificate consists of 2 pages.



Kai-Jens Schulz-Reifer
Kai-Jens Schulz-Reifer



Components necessary for operation:

Components necessary for operation	Part No.	Remarks
NAUTICAST™ AIS	2607	Software-Version: 2.0.S105
Connection Box	2640	
GPS Antenna AIS-A W/5M Coax	2639	
VH-3200 VHF Stainless Steel Whip Antenna 91.4cm (36in)	2628	or equivalent

The internal GPS sensor of the NAUTICAST™ AIS is used as backup sensor for position reporting

Documentation:

User Manual	NAUTICAST Automatic Identification System:	Y1-03-0203 Rev. L (2009-04-01)
Installation Manual	NAUTICAST Automatic Identification System:	Y1-03-0204 Rev. K (2009-04-01)

Trade names:

The equipment is also available under the following trade names:

Company	Product Name	ACR Part No. of AIS transponder unit:
ACR	NAUTICAST™2 AIS	2609
ACR	NAUTICAST™ Inland AIS (in SOLAS Mode)	2662

Limitations on the acceptance or use of the product:

Notes:

The manufacturer shall inform Bundesamt für Seeschifffahrt und Hydrographie, as the notified body, of any modifications to the type-tested product(s) that may affect compliance with the requirements or conditions laid down for use of the product(s).

In case the specified regulations or standards are amended during the validity of this certificate, the product(s) must be re-certified before being placed on board vessels to which such amended regulations or standards apply.

The Mark of Conformity (wheelmark) may only be affixed to the type approved equipment, and a Manufacturer's Declaration of Conformity may only be issued, if the product quality system fully complies with the Marine Equipment Directive and is certified by a notified body against ANNEX B module D, E, or F of the Directive.

Notice on legal remedies available:

Objection to this document may be filed within one month after notification. The objection must be filed in writing to, or put on record at, Federal Maritime and Hydrographic Agency, Bernhard-Nocht-Str. 78, 20359 Hamburg, Germany



Bundesrepublik Deutschland

Federal Republic of Germany

Bundesamt für Seeschifffahrt und Hydrographie

Federal Maritime and Hydrographic Agency



BUNDESAMT FÜR
SEESCHIFFFAHRT
UND
HYDROGRAPHIE

EC QUALITY SYSTEM (MODULE D) CERTIFICATE

Bundesamt für Seeschifffahrt und Hydrographie (Federal Maritime and Hydrographic Agency) as the notified body performing EC conformity assessment procedures in compliance with EC Council Directive 96/98/EC of 20 December 1996 on Marine Equipment, last amended by EC Commission Directive 2009/26/EC of 06 April 2009, hereby certifies that a quality system in accordance with the requirements of the Marine Equipment Directive Annex B, Module D is maintained and applied by the manufacturer:

ACR Electronics, Inc.
5757 Ravenswood Road
FORT LAUDERDALE, FL 33312
USA

Scope:

- A.1/1.2c Position-indicating lights for life-saving appliances:
- for lifejackets
- A.1/4.18 9-GHz SAR transponder (SART)
- A.1/4.32 Universal automatic identification system equipment (AIS)
- A.1/5.6 406 MHz EPIRB (COSPAS-SARSAT)

References: see overleaf

Date of issue: 2009-06-19

Issued by: Bundesamt für Seeschifffahrt und Hydrographie, Hamburg

Expiry date: 2012-06-18

Identification number 0735

Registration no.: BSH/4613/05102/1251/09

This certificate consists of 2 pages



by order

Ingolff Eckert
Ingolff Eckert



Places of production

ACR Electronics, Inc
5757 Ravenswood Road
Fort Lauderdale, FL 33312, USA

Restrictions:

References:

See annex

Notes:

This certificate authorises the manufacturer in conjunction with the EC Type Examination (Module B) Certificate of the equipment listed in the scope to affix the "Mark of Conformity" (wheelmark).

This certificate loses its validity if the manufacturer makes any changes or modifications to the approved quality system, which have not been notified to, and agreed with the notified body named on this certificate and/or after lapse of time, withdrawal or revocation of the EC Type Examination (Module B) Certificate.

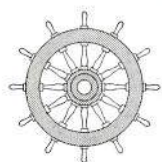
"Wheelmark" Format and application:

yy Last two digits of the year in which mark is affixed.
0735 Notified Body number undertaking quality surveillance

0735/yy

example

Notice on legal remedies available:

Objection to this document may be filed within one month after notification. The objection must be filed in writing to, or put on record at, Federal Maritime and Hydrographic Agency, Bernhard-Nocht-Str. 78, 20359 Hamburg, Germany

**Annex to
EC QUALITY SYSTEM (MODULE D) CERTIFICATE**

No. BSH/4613/05102/1251/09



BUNDESAMT FÜR
SEESCHIFFFAHRT
UND
HYDROGRAPHIE

Item	Module B Certificate data				
	Registration number	date of issue	date of expiry	Notified Body	
	USCG Approval No.				
A.1/1.2c	Position-indicating lights for life-saving appliances: - for lifejackets				
	HL8-10	BSH/4612/1021250/09	2009-06-19	2014-06-18	0735
		---	---	---	---
A.1/4.18	9 GHz SAR transponder (SART)				
	ACR Pathfinder 3 SART	QQ-MED-22/08-01	2008-11-06	2013-11-05	0191
		---	---	---	---
A.1/4.32	Universal automatic identification system equipment (AIS)				
	NAUTICAST™ AIS	BSH/4612/4321220/09	2009-07-21	2014-07-20	0735
		---	---	---	---
A.1/5.6	406 MHz EPIRB (COSPAS-SARSAT)				
	RLB-36 / RLB-37	BSH/4612/5061395/09	2009-10-20	2014-10-19	0735
		---	---	---	---
	RLB-36	BSH/4612/5060959/08	2008-09-19	2013-09-18	0735
		---	---	---	---
	RLB-35	BSH/4612/5060372/06	2006-10-04	2011-10-03	0735
		---	---	---	---
	Global Fix 406	4612/5060016/2005	2005-03-15	2010-03-14	0735
		---	---	---	---
	Satellite ₂ 406	6492/050564-1/2004	2004-12-20	2009-12-19	0735
		---	---	---	---
	Rapid Fix 406	6492/050564-2/2004	2004-12-20	2009-12-19	0735
		---	---	---	---

Hamburg, 2009-10-20



Notice on legal remedies available:

Objection to this document may be filed within one month after notification. The objection must be filed in writing to, or put on record at, Federal Maritime and Hydrographic Agency, Bernhard-Nocht-Str. 78, 20359 Hamburg, Germany
V 2008-04-16



EG - Konformitätserklärung EC - Declaration of Conformity

Diese Konformitätserklärung bestätigt, dass das unten benannte Zubehör gleich oder besser dem im untenstehenden Zertifikat ausgewiesenen Zubehör ist.

This declaration of conformity certifies that the mentioned accessory is equal or better to the equipment stated in the beyond Certificate.

Produktbezeichnung: Product Name / Nom du produit	NAUTICAST™ AIS
OEM Name: Trade Name / Marque Déposée	NAUTICAST™ Inland AIS (in SOLAS Mode), NAUTICAST™2 AIS
Zertifikate der benannten Stelle: Certificates from the notified Body / Certificats des Organismes Notifiés	EC Type Examination (Module B) Certificate: BSH/4612/4321220/09 EC Quality System (Module D) Certificate: BSH/4613/05102/1251/09 Issued by: Bundesamt für Seeschifffahrt und Hydrographie (BSH), Notified Body No. 0735 Bernhard-Nocht-Str. 78, 20359 Hamburg, Germany Inland AIS Type Approval Certificate No: R - 4 - 203 Issued by: Fachstelle der WSV für Verkehrstechniken Weinbergstraße 11-13, 56070 Koblenz, Germany
Spezifizierte Standards: Specified Standard(s) / Standard(s) Spécifié(s)	IMO MSC.74(69) Annex 3 ITU-R M.1371-3 (Class A) IALA Technical Clarifications of Rec. ITU-R M.1371-1 (Ed. 1.3) ITU-R M.825-3 ITU-R M1084-3 IEC 61993-2 (2001) IEC 61162-1 (2000), -2 (1998) IEC 60945 (1996) IEC 61108-1 (1996) Technical Specification for Vessel Tracking and Tracing Systems for Inland Waterways (Ed. 1.01 dated 10.10.2007) Test Standard for Inland AIS,(Edition 1.0 dated 31.5.2007)
Zubehörtyp: Type of Accessory	Combined GPS/VHF Antenna Comrod AC17 combined GPS/VHF Antenna + Splitter (in Cable integrated)
ACR Part Number: Einschränkungen / Hinweise Restrictions / Comments	2624 Verlegte Kabellänge < 40m Installed Cable lenght <40m
Dokumentnummer: Document number / Num. du document	2009-05
Hersteller: Manufacturer / Fabricant	ACR Electronics Inc., 5757 Ravenswood Road, Fort Lauderdale, Florida, 33312 USA
Anschrift EU-Vertretung: Address EU-Representative / Adresse du Représentant pour l'UE	ACR Electronics Europe GmbH Handelskai 388 / Top 632 A-1020 Vienna, Austria
Ort, Datum: place, date / Lieu,Date	Vienna, 2009-07-22
Unterschrift: Signature / Signature	 Andreas Lesch Managing Director

Diese Erklärung bescheinigt die Übereinstimmung mit den genannten Richtlinien, ist jedoch keine Zusicherung von Eigenschaften. Die Sicherheitshinweise der mitgelieferten Produktdokumentation sind zu beachten.

This declaration certifies the compliance with the indicated directives but implies no warranty of properties. The safety instructions of the accompanying product documentation shall be observed.

Cette déclaration certifie la conformité avec les directives indiquées mais n'implique aucune garantie des propriétés. Les instructions de sécurité de la documentation accompagnant le produit doivent être suivies.

ISO 9001:2000 Zertifizierung / ISO 9001:2000 Certification

ACR Electronics Europe GmbH hat ein Qualitätsmanagement System nach ISO 9001:2000 implementiert, und ist seit Juli 2003 ISO-zertifiziert.

ACR Electronics Europe GmbH maintains a Quality Management System according to ISO 9001:2000, and received ISO certification in July 2003.



EG - Konformitätserklärung EC - Declaration of Conformity

Diese Konformitätserklärung bestätigt, dass das unten benannte Zubehör gleich oder besser dem im untenstehenden Zertifikat ausgewiesenen Zubehör ist.

This declaration of conformity certifies that the mentioned accessory is equal or better to the equipment stated in the beyond Certificate.

Produktbezeichnung: Product Name / Nom du produit	NAUTICAST™ AIS
OEM Name: Trade Name / Marque Déposée	NAUTICAST™ Inland AIS (in SOLAS Mode), NAUTICAST™2 AIS
Zertifikate der benannten Stelle: Certificates from the notified Body / Certificats des Organismes Notifiés	EC Type Examination (Module B) Certificate: BSH/4612/4321220/09 EC Quality System (Module D) Certificate: BSH/4613/05102/1251/09 Issued by: Bundesamt für Seeschifffahrt und Hydrographie (BSH), Notified Body No. 0735 Bernhard-Nocht-Str. 78, 20359 Hamburg, Germany Inland AIS Type Approval Certificate No: R - 4 - 203 Issued by: Fachstelle der WSV für Verkehrstechniken Weinbergstraße 11-13, 56070 Koblenz, Germany
Spezifizierte Standards: Specified Standard(s) / Standard(s) Spécifié(s)	IMO MSC.74(69) Annex 3 ITU-R M.1371-3 (Class A) IALA Technical Clarifications of Rec. ITU-R M.1371-1 (Ed. 1.3) ITU-R M.825-3 ITU-R M1084-3 IEC 61993-2 (2001) IEC 61162-1 (2000), -2 (1998) IEC 60945 (1996) IEC 61108-1 (1996) Technical Specification for Vessel Tracking and Tracing Systems for Inland Waterways (Ed. 1.01 dated 10.10.2007) Test Standard for Inland AIS,(Edition 1.0 dated 31.5.2007)
Zubehörtyp: Type of Accessory	VHF Antenna Comrod AV-7
ACR Part Number:	2621
Dokumentnummer: Document number / Num. du document	2009-06
Hersteller: Manufacturer / Fabricant	ACR Electronics Inc., 5757 Ravenswood Road, Fort Lauderdale, Florida, 33312 USA
Anschrift EU-Vertretung: Address EU-Representative / Adresse du Représentant pour l'UE	ACR Electronics Europe GmbH Handelskai 388 / Top 632 A-1020 Vienna, Austria
Ort, Datum: place, date / Lieu,Date	Vienna, 2009-07-22
Unterschrift: Signature / Signature	 Andreas Lesch Managing Director

Diese Erklärung bescheinigt die Übereinstimmung mit den genannten Richtlinien, ist jedoch keine Zusicherung von Eigenschaften. Die Sicherheitshinweise der mitgelieferten Produktdokumentation sind zu beachten.
This declaration certifies the compliance with the indicated directives but implies no warranty of properties. The safety instructions of the accompanying product documentation shall be observed.
Cette déclaration certifie la conformité avec les directives indiquées mais n'implique aucune garantie des propriétés. Les instructions de sécurité de la documentation accompagnant le produit doivent être suivies.

ISO 9001:2000 Zertifizierung / ISO 9001:2000 Certification
ACR Electronics Europe GmbH hat ein Qualitätsmanagement System nach ISO 9001:2000 implementiert, und ist seit Juli 2003 ISO-zertifiziert.
ACR Electronics Europe GmbH maintains a Quality Management System according to ISO 9001:2000, and received ISO certification in July 2003.



EG - Konformitätserklärung EC - Declaration of Conformity

Diese Konformitätserklärung bestätigt, dass das unten benannte Zubehör gleich oder besser dem im untenstehenden Zertifikat ausgewiesenen Zubehör ist.

This declaration of conformity certifies that the mentioned accessory is equal or better to the equipment stated in the beyond Certificate.

Produktbezeichnung: Product Name / Nom du produit	NAUTICAST™ AIS
OEM Name: Trade Name / Marque Déposée	NAUTICAST™ Inland AIS (in SOLAS Mode), NAUTICAST™2 AIS
Zertifikate der benannten Stelle: Certificates from the notified Body / Certificats des Organismes Notifiés	EC Type Examination (Module B) Certificate: BSH/4612/4321220/09 EC Quality System (Module D) Certificate: BSH/4613/05102/1251/09 Issued by: Bundesamt für Seeschifffahrt und Hydrographie (BSH), Notified Body No. 0735 Bernhard-Nocht-Str. 78, 20359 Hamburg, Germany Inland AIS Type Approval Certificate No: R - 4 - 203 Issued by: Fachstelle der WSV für Verkehrstechniken Weinbergstraße 11-13, 56070 Koblenz, Germany
Spezifizierte Standards: Specified Standard(s) / Standard(s) Spécifié(s)	IMO MSC.74(69) Annex 3 ITU-R M.1371-3 (Class A) IALA Technical Clarifications of Rec. ITU-R M.1371-1 (Ed. 1.3) ITU-R M.825-3 ITU-R M1084-3 IEC 61993-2 (2001) IEC 61162-1 (2000), -2 (1998) IEC 60945 (1996) IEC 61108-1 (1996) Technical Specification for Vessel Tracking and Tracing Systems for Inland Waterways (Ed. 1.01 dated 10.10.2007) Test Standard for Inland AIS,(Edition 1.0 dated 31.5.2007)
Zubehörtyp: Type of Accessory	GPS Antenna Procom GPS 4 Antenna
ACR Part Number: Einschränkungen / Hinweise Restrictions / Comments	2622 Verlegte Kabellänge < 40m Installed Cable length <40m
Dokumentnummer: Document number / Num. du document	2009-07
Hersteller: Manufacturer / Fabricant	ACR Electronics Inc., 5757 Ravenswood Road, Fort Lauderdale, Florida, 33312 USA
Anschrift EU-Vertretung: Address EU-Representative / Adresse du Représentant pour l'UE	ACR Electronics Europe GmbH Handelskai 388 / Top 632 A-1020 Vienna, Austria
Ort, Datum: place, date / Lieu,Date	Vienna, 2009-07-22
Unterschrift: Signature / Signature	 Andreas Lesch Managing Director

Diese Erklärung bescheinigt die Übereinstimmung mit den genannten Richtlinien, ist jedoch keine Zusicherung von Eigenschaften. Die Sicherheitshinweise der mitgelieferten Produktdokumentation sind zu beachten.

This declaration certifies the compliance with the indicated directives but implies no warranty of properties. The safety instructions of the accompanying product documentation shall be observed.

Cette déclaration certifie la conformité avec les directives indiquées mais n'implique aucune garantie des propriétés. Les instructions de sécurité de la documentation accompagnant le produit doivent être suivies.

ISO 9001:2000 Zertifizierung / ISO 9001:2000 Certification

ACR Electronics Europe GmbH hat ein Qualitätsmanagement System nach ISO 9001:2000 implementiert, und ist seit Juli 2003 ISO-zertifiziert.

ACR Electronics Europe GmbH maintains a Quality Management System according to ISO 9001:2000, and received ISO certification in July 2003.



EG - Konformitätserklärung EC - Declaration of Conformity

Diese Konformitätserklärung bestätigt, dass das unten benannte Produkt den Auflagen der EC Council Directive 96/98/EC vom 20 Dezember 1996 für maritime Ausrüstung, geändert durch die EC Council Directive 2002/75/EC vom 2. September 2002 entspricht und von der benannten Stelle Nr. 0735 (BSH) typengeprüft wurde. Darüber hinaus ist die Konformität gemäß Commission Regulation (EC) No. 415/2007 zum „Standard Schiffsverfolgung und Aufspürung in der Binnenschifffahrt, Edition 1.01 vom 10.10.2007“ sowie zum „Test Standard for Inland AIS Edition 1.0“ vom 31. May 2007 gewährleistet.

This declaration of conformity certifies that the specified equipment is in compliance with EC Council Directive 96/98/EC of 20 December 1996 on Marine Equipment (MED), as amended by Commission Directive 2002/75/EC of 2 September 2002. The Commission Regulation (EC) No. 415/2007 concerning Vessel Tracking and Tracing Systems on Inland Waterways, defined in the Test Standard for Inland AIS Edition 1.0 of 31st May 07 has been type examined.

Produktbezeichnung: Product Name / Nom du produit	NAUTICAST™ Inland AIS
OEM Name: Trade Name / Marque Déposée	NAUTICAST™ Inland AIS
Zertifikate der benannten Stelle: Certificates from the notified Body / Certificats des Organismes Notifiés	EC Type Examination (Module B) Certificate: BSH/4612/4321220/09 EC Quality System (Module D) Certificate: BSH/4613/05102/1251/09 Issued by: Bundesamt für Seeschifffahrt und Hydrographie (BSH), Notified Body No. 0735 Bernhard-Nocht-Str. 78, 20359 Hamburg, Germany Inland AIS Type Approval Certificate No: R - 4 - 203 Issued by: Fachstelle der WSV für Verkehrstechniken Weinbergstraße 11-13, 56070 Koblenz, Germany
Spezifizierte Standards: Specified Standard(s) / Standard(s) Spécifié(s)	IMO MSC.74(69) Annex 3 ITU-R M.1371-3 (Class A) IALA Technical Clarifications of Rec. ITU-R M.1371-1 (Ed. 1.3) ITU-R M.825-3 ITU-R M1084-3 IEC 61993-2 (2001) IEC 61162-1 (2000), -2 (1998) IEC 60945 (1996) IEC 61108-1 (1996) Technical Specification for Vessel Tracking and Tracing Systems for Inland Waterways (Ed. 1.01 dated 10.10.2007) Test Standard for Inland AIS, (Edition 1.0 dated 31.5.2007)
Dokumentnummer: Document number / Num. du document	2009-08
Hersteller: Manufacturer / Fabricant	ACR Electronics Inc., 5757 Ravenswood Road, Fort Lauderdale, Florida, 33312 USA
Anschrift EU-Vertretung: Address EU-Representative / Adresse du Représentant pour l'UE	ACR Electronics Europe GmbH Handelskai 388 / Top 632 A-1020 Vienna, Austria
Ort, Datum: place, date / Lieu, Date	Vienna, 2009-07-22
Unterschrift: Signature / Signature	 Andreas Lesch Managing Director

Diese Erklärung bescheinigt die Übereinstimmung mit den genannten Richtlinien, ist jedoch keine Zusicherung von Eigenschaften. Die Sicherheitshinweise der mitgelieferten Produktdokumentation sind zu beachten.

This declaration certifies the compliance with the indicated directives but implies no warranty of properties. The safety instructions of the accompanying product documentation shall be observed.

Cette déclaration certifie la conformité avec les directives indiquées mais n'implique aucune garantie des propriétés. Les instructions de sécurité de la documentation accompagnant le produit doivent être suivies.

ISO 9001:2000 Zertifizierung / ISO 9001:2000 Certification

ACR Electronics Europe GmbH hat ein Qualitätsmanagement System nach ISO 9001:2000 implementiert, und ist seit Juli 2003 ISO-zertifiziert.

ACR Electronics Europe GmbH maintains a Quality Management System according to ISO 9001:2000, and received ISO certification in July 2003.



EG - Konformitätserklärung EC - Declaration of Conformity

Diese Konformitätserklärung bestätigt, dass das unten benannte Zubehör gleich oder besser dem im untenstehenden Zertifikat ausgewiesenen Zubehör ist.

This declaration of conformity certifies that the mentioned accessory is equal or better to the equipment stated in the beyond Certificate.

Produktbezeichnung: Product Name / Nom du produit	NAUTICAST™ AIS
OEM Name: Trade Name / Marque Déposée	NAUTICAST™ Inland AIS (in SOLAS Mode), NAUTICAST™2 AIS
Zertifikate der benannten Stelle: Certificates from the notified Body / Certificats des Organismes Notifiés	EC Type Examination (Module B) Certificate: BSH/4612/4321220/09 EC Quality System (Module D) Certificate: BSH/4613/05102/1251/09 Issued by: Bundesamt für Seeschifffahrt und Hydrographie (BSH), Notified Body No. 0735 Bernhard-Nocht-Str. 78, 20359 Hamburg, Germany Inland AIS Type Approval Certificate No: R - 4 - 203 Issued by: Fachstelle der WSV für Verkehrstechniken Weinbergstraße 11-13, 56070 Koblenz, Germany
Spezifizierte Standards: Specified Standard(s) / Standard(s) Spécifié(s)	IMO MSC.74(69) Annex 3 ITU-R M.1371-3 (Class A) IALA Technical Clarifications of Rec. ITU-R M.1371-1 (Ed. 1.3) ITU-R M.825-3 ITU-R M1084-3 IEC 61993-2 (2001) IEC 61162-1 (2000), -2 (1998) IEC 60945 (1996) IEC 61108-1 (1996) Technical Specification for Vessel Tracking and Tracing Systems for Inland Waterways (Ed. 1.01 dated 10.10.2007) Test Standard for Inland AIS,(Edition 1.0 dated 31.5.2007)
Zubehörtyp: Type of Accessory	GPS Antenna ACR GPS Antenna (28dB Gain)
ACR Part Number: Einschränkungen / Hinweise Restrictions / Comments	2637 Verlegte Kabellänge < 40m Installed Cable lenght <40m
Dokumentnummer: Document number / Num. du document	2009-10
Hersteller: Manufacturer / Fabricant	ACR Electronics Inc., 5757 Ravenswood Road, Fort Lauderdale, Florida, 33312 USA
Anschrift EU-Vertretung: Address EU-Representative / Adresse du Représentant pour l'UE	ACR Electronics Europe GmbH Handelskai 388 / Top 632 A-1020 Vienna, Austria
Ort, Datum: place, date / Lieu,Date	Vienna, 2009-09-16
Unterschrift: Signature / Signature	 Andreas Lesch Managing Director

Diese Erklärung bescheinigt die Übereinstimmung mit den genannten Richtlinien, ist jedoch keine Zusicherung von Eigenschaften. Die Sicherheitshinweise der mitgelieferten Produktdokumentation sind zu beachten.

This declaration certifies the compliance with the indicated directives but implies no warranty of properties. The safety instructions of the accompanying product documentation shall be observed.

Cette déclaration certifie la conformité avec les directives indiquées mais n'implique aucune garantie des propriétés. Les instructions de sécurité de la documentation accompagnant le produit doivent être suivies.

ISO 9001:2000 Zertifizierung / ISO 9001:2000 Certification

ACR Electronics Europe GmbH hat ein Qualitätsmanagement System nach ISO 9001:2000 implementiert, und ist seit Juli 2003 ISO-zertifiziert.

ACR Electronics Europe GmbH maintains a Quality Management System according to ISO 9001:2000, and received ISO certification in July 2003.